

**Buildings to be Planned for Use by Persons with a Disability
Regulation 72 of Building (Planning) Regulations
Design Manual: Barrier Free Access 2008**

Pursuant to section 84 of the Disability Discrimination Ordinance (Cap. 487), the Building Authority (BA), as a public authority which has the power to approve building works shall not, in respect of those works, approve plans, whether for a new building or for the alterations or additions to an existing building unless the person seeking approval satisfies the BA that such access as is reasonable in the circumstances to the building or premises will be provided for persons with a disability. The Building (Planning) Regulations (B(P)R) also require certain categories of buildings to be planned for use by persons with a disability. Access and facilities for persons with a disability (collectively referred to as “barrier free access”) shall be incorporated in a building at the design stage of the project, to comply with the legislation.

Relevant Building Regulations

2. The regulations stipulating requirements for buildings to be planned for use by persons with a disability include regulation 8(1)(m) of the Building (Administration) Regulations (B(A)R), regulations 2(1), 39(3)(e) and 72 and the Third Schedule of the B(P)R and regulation 61(3) of the Building (Standards of Sanitary Fittings, Plumbing, Drainage Works and Latrines) Regulations.

3. Regulation 72 of the B(P)R and the Third Schedule thereto set out the statutory requirements for barrier free access in private buildings. The B(P)R are supplemented by the Design Manual: Barrier Free Access 2008 (Design Manual 2008) which has incorporated the statutory design requirements as well as recommendations for best practice to improve the barrier free access.

4. Part 4 of the Third Schedule to the B(P)R identifies those categories of buildings (including domestic, non-domestic and composite buildings) where limited barrier free access are to be provided under regulation 72 of the B(P)R. Save for those buildings which are exempted under regulation 72(4) of the B(P)R, all other buildings not included in Part 4 of the Third Schedule are required to comply fully with the regulations.

Exemption from or Modification of Regulation 72 of B(P)R

5. In an application for approval of plans for a new building or for the alterations or additions to an existing building, barrier free access should be clearly shown on the submitted plans in accordance with regulation 8(1)(m) of the B(A)R.

6. There are occasions where proposals for building development cannot meet the full requirements for barrier free access stipulated in the regulations. Exemption from or modification of the regulations will be considered by the BA on individual merits of each case. The BA is prepared to consider applications to vary the requirements provided that the BA is satisfied that special circumstances exist. Examples of special circumstances include the physical location and immediate environs of a development site render compliance with the legislation impracticable or where such provisions would impose unjustifiable hardship on the applicant or any other person. The circumstances under which the BA may consider such applications are outlined in Appendix A.

Alteration and Addition Submissions

7. Where alteration and addition works are proposed to an existing building without initial access for persons with a disability, all practical measures should be taken to provide suitable barrier free access. Applications for exemption citing the prevailing special circumstances would be considered on a case by case basis.

Advisory Committee on Barrier Free Access

8. In considering applications for exemption from or modification of the regulations, the BA has established an advisory committee namely Advisory Committee on Barrier Free Access (ACBFA) to provide a forum for the deliberation and discussion of the proposals. The BA will take into account the advice given by the ACBFA in making decisions on the applications. The terms of reference and membership of the ACBFA are at Appendix B.

Amendments to Design Manual 2008

9. The Buildings Department (BD) has set up a technical committee (TC) to, among others, collect and consider the views and feedback from the building sector, rehabilitation sector and relevant stakeholder organisations arising from their practical experience in the use of the Design Manual 2008. Taking into account the advice of the TC, the following amendments to the Design Manual 2008 have been promulgated and Design Manual 2008 (2021 Edition) incorporating all these amendments has been uploaded to BD website www.bd.gov.hk:

- (a) Appendix C – November 2012;
- (b) Appendix D – September 2015;
- (c) Appendix E – April 2017;
- (d) Appendix F – June 2019;
- (e) Appendix G – October 2020; and
- (f) Appendix H – December 2021.

More Accessible Built Environment

10. The Design Manual 2008 has already provided certain design guidelines for the elderly to enhance their health and safety and to facilitate their movement within buildings, particularly for elderly with infirmities in vision, hearing or locomotion. These guidelines and design requirements will also benefit people with other forms of physical infirmities or limitations such as pregnant women and families with young children. Authorized persons are therefore encouraged to recommend to their clients to incorporate these facilities in their developments.



(YU Po-mei, Clarice)
Building Authority

Ref. : BD GP/BREG/P/25(XII)

This PNAP is previously known as PNAP 112

First issue April 1985

Last revision October 2020

This revision December 2021 (AD/NB1) (Paragraph 9 amended and Appendix H added)

Building (Planning) Regulation 72

**Special Circumstances that may be Acceptable to the Building Authority
for Applications to Vary Provisions**

For alterations and additions works to existing buildings where initial access for persons with a disability is not provided, the Building Authority would be satisfied with the design of the building in respect of the non-provision of facilities for persons with locomotory disabilities in cases where the provision of a ramp access would involve alteration works to the common parts of a building and where the applicant can demonstrate that :

- the applicant has no control over the area;
- consent from co-owners or owners' corporation to permit the carrying out of the alteration works to the common parts of the building is declined or cannot be obtained; and
- where ground beam is involved, there is spatial or structural constraint.

Advisory Committee on Barrier Free Access (ACBFA)

Terms of Reference

The terms of reference of ACBFA are to offer advice to the Building Authority in relation to plans submitted for a new building or for alteration and addition to an existing building as to whether reasonable access and facilities will be provided in the building for persons with a disability. In arriving at such an advice, the Committee should consider the following :

- the standards and requirements contained in Building (Planning) Regulation 72, the Design Manual - Barrier Free Access 2008 and any other relevant statutory provisions;
- whether it is practicable to provide such access within the curtilage of the building, bearing in mind the physical location and immediate environs of the building; and
- whether providing such access would impose unjustifiable hardship on the person seeking approval or any other person.

Membership

The membership of ACBFA is as follows :

- Chairman : Assistant Director/New Buildings 1, Buildings Department
- Members : A representative of the Commissioner for Rehabilitation
A representative of the Director of Architectural Services
A representative (authorized person) appointed by the Director of Buildings
A lay member appointed by the Director of Buildings
Three representatives nominated by the Commissioner for Rehabilitation representing the physically handicapped, visually impaired and hearing impaired respectively
Technical Secretary/Building, Buildings Department
- Secretary : Building Surveyor/Technical Services 3, Buildings Department
- In attendance : The Senior Building Surveyor or Building Surveyor of the case

Amendments to the Design Manual: Barrier Free Access 2008

(November 2012)

Legends:



Amended



Deleted

@

Obligatory Design Requirements

*

Recommended Design Requirements under Best Practice Section

Item

2008 version

Amendments

1. Figure 16A
(Paragraph
30 in
Division
8)@

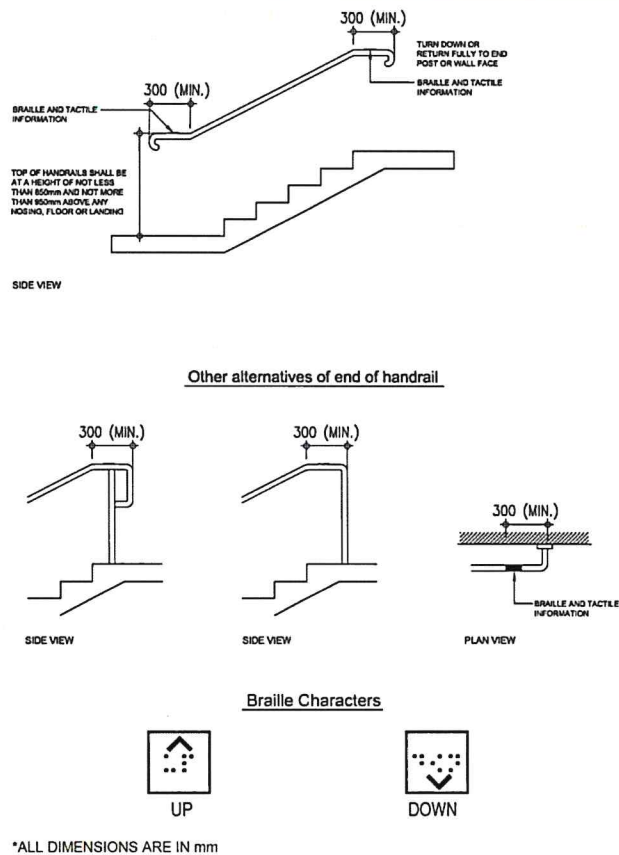
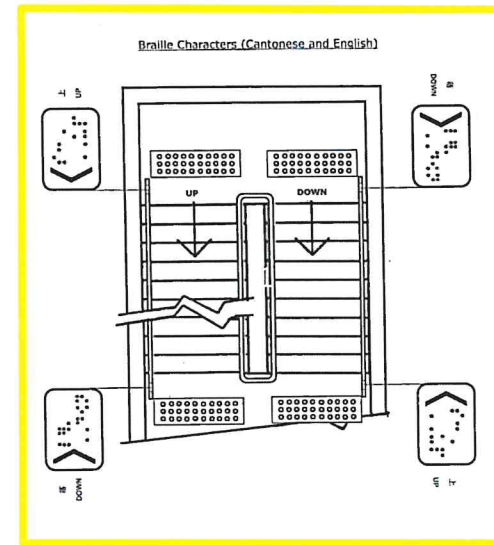
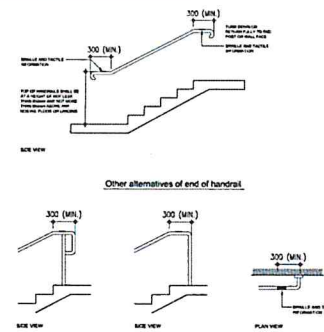
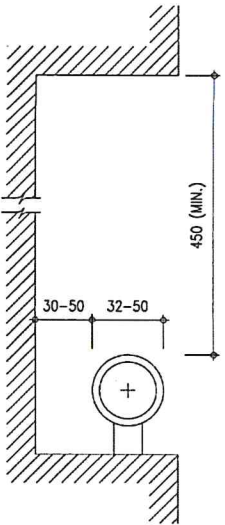
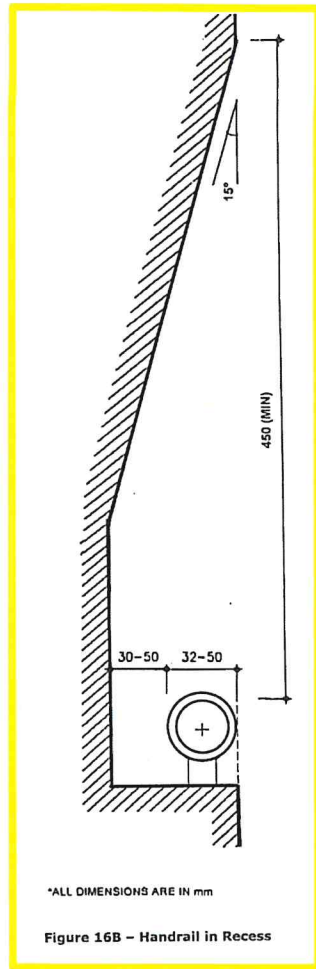

Figure 16A – Handrails of Staircase



*ALL DIMENSIONS ARE IN mm

Figure 16A – Handrails of Staircase

Item	2008 version	Amendments
<p>2. Figure 16B (Paragraph B(b) in Division 8)*</p>	 <p>*ALL DIMENSIONS ARE IN mm</p> <p>Figure 16B – Handrail in Recess</p>	 <p>*ALL DIMENSIONS ARE IN mm</p> <p>Figure 16B – Handrail in Recess</p>

Item

2008 version

Amendments

3. Figure 24
(Division
11)*

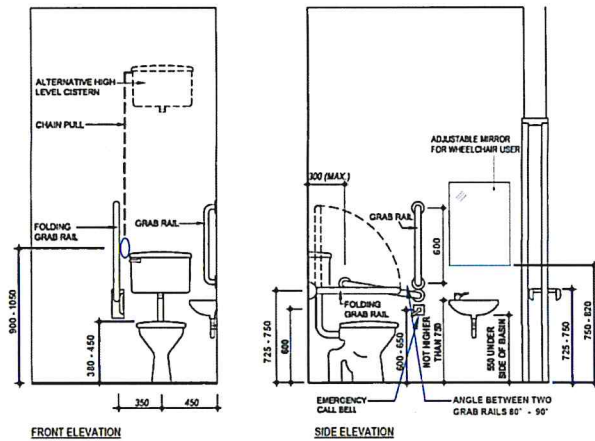

FRONT ELEVATION

SIDE ELEVATION



PLAN

*ALL DIMENSIONS ARE IN mm
DIMENSIONS PRINTED IN BOLD FORM DENOTE OBLIGATORY REQUIREMENT
DIMENSIONS PRINTED IN ITALIC FORM DENOTE RECOMMENDED REQUIREMENT

(Opposite - Handed Layout is Acceptable)

Figure 24 – Accessible Toilet

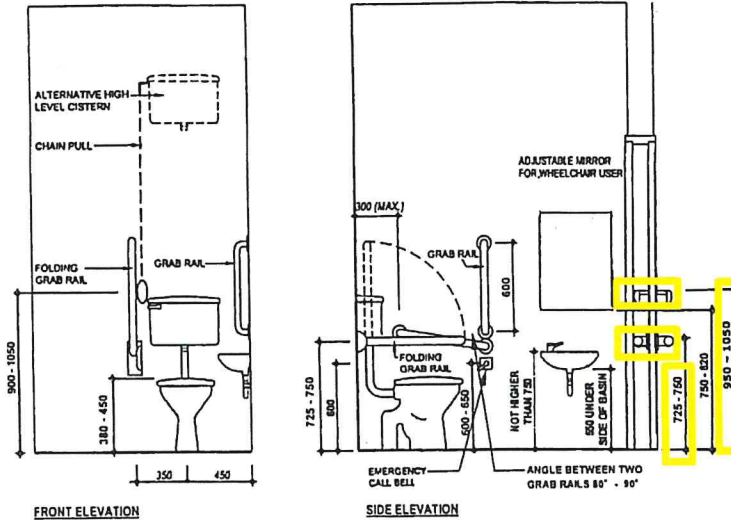

FRONT ELEVATION

SIDE ELEVATION

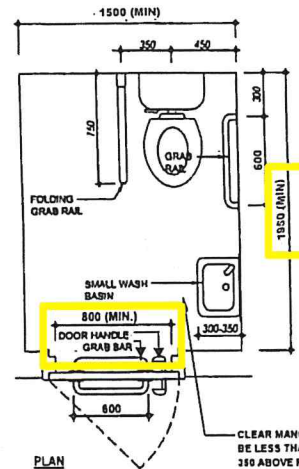

PLAN

*ALL DIMENSIONS ARE IN mm
DIMENSIONS PRINTED IN BOLD FORM DENOTE OBLIGATORY REQUIREMENT
DIMENSIONS PRINTED IN ITALIC FORM DENOTE RECOMMENDED REQUIREMENT

(Opposite - Handed Layout is Acceptable)

Figure 24 – Accessible Toilet

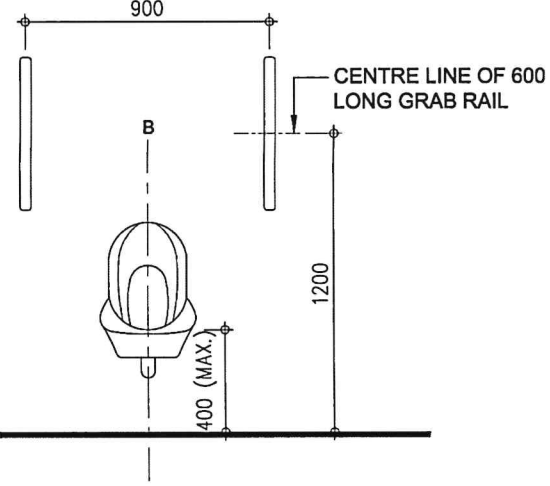
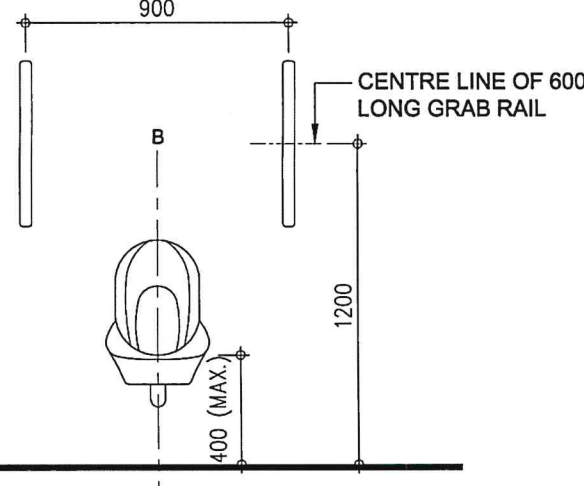
Item	2008 version	Amendments
<p>4. Figure 25 (Paragraph 55(ii) in Division 11)@</p>	 <p>900</p> <p>CENTRE LINE OF 600 LONG GRAB RAIL</p> <p>B</p> <p>1200</p> <p>400 (MAX.)</p> <p>*ALL DIMENSIONS ARE IN mm</p> <p>Figure 25 – Accessible Urinal</p>	 <p>900</p> <p>CENTRE LINE OF 600 LONG GRAB RAIL</p> <p>B</p> <p>1200</p> <p>400 (MAX.)</p> <p>*ALL DIMENSIONS ARE IN mm</p> <p>Figure 25 - Urinal for Use by Persons with Ambulant Disabilities</p>
<p>5. Page 101 (Division 19 of Chapter 4)*</p>		<p>To add paragraph B(bb) in Page 101</p> <p>As an alternative to providing lift control buttons inside the lift car as stipulated in paragraph 80(1), the adoption of a Destination Control System (DCS) should comply with the following: -</p> <ul style="list-style-type: none"> (a) The keypad control of the DCS to be installed in a conspicuous place in the lift hall shall have the built-in design for the use of persons with a disability. (b) The keypad shall be of standard telephone keypad type with raised dot for easy orientation at number 5 key. An appropriate Braille notice “lift button for the visually impaired” shall be provided. (c) The keypad shall have an “international wheelchair” button to activate the system specially designed for the persons with a disability and a push button with a symbol in a “star” shape for identifying the main entrance floor for the use of visually impaired users.

Item	2008 version	Amendments
		<p>(d) Tactile Arabic numerals with suitable design (e.g. 15mm high) and normally engraved by 1mm instead of Braille shall be provided on the keypad.</p> <p>(e) The user shall be able to know that the DCS has been operated. The call registration shall be confirmed by a visible and audible signal. The audible signal shall be given on every individual call registration even if the call is already registered. Also, a speech output system (in Cantonese, Putonghua and English) of the keypad for verification of the designated floor shall be provided.</p> <p>(f) All essential buttons including emergency alarm push button, intercom controls, and the door opening push button shall be provided inside the lift car.</p> <p>(g) The keypad at the lift hall and all the essential buttons in the lift car shall be located between 900mm and 1200mm above the finished floor level of the lift hall or the floor of the lift car in compliance with section 80(2) of the Third Schedule to the Building (Planning) Regulations and paragraph 80(2) in Division 19.</p> <p>(h) The design of the keypad shall comply with the international standards for the use of persons with a disability such as the European Standard EN 81-70:2003, Safety rules for the construction and installations of lifts - Particular applications for passenger and goods passenger lifts - Part 70: Accessibility to lifts for persons including persons with disability. Adequate signal and indication for use shall be provided including an illuminated visual indicator and an audible signal.</p> <p>(i) Braille and tactile plate indicating the user's instruction shall be mounted on the wall adjacent to the keypad reachable by the visually impaired users. The instruction shall be in both English and Chinese.</p> <p>(j) When the "wheelchair" button is pushed, the gong sound and voice announcement (in Cantonese, Putonghua and English) will be activated on the arrival of the accessible lift. To allow the persons with a disability to catch the lift, time allowed for keeping the lift door open and the response time for the keypad shall be suitably extended.</p>

Item	2008 version	Amendments
		(k) Tactile guide path shall be provided to guide the visually impaired users to the keypad in the lift hall and then to the designated accessible lift.

Amendments to the Design Manual: Barrier Free Access 2008
(September 2015)

Legends:

 Amended

 Deleted

Item	2008 version	Amendments
1. Paragraph 5.5 B(a)(vi) in Chapter 5 ¹	lift buttons should comply with paragraphs 80(1) and (4) in Division 19;	lift buttons and emergency call button should comply with paragraphs 80(1) to 80(8) and 80(i) and 80(ii) in Division 19;
2. Paragraph 5.5 B(a)(viii) in Chapter 5	grab bars complying with paragraphs 28(3) and (4) in Division 8 should be placed at a height of 900mm from the finished floor level and be fixed on both sides and at the rear of the lift car;	grab bars complying with paragraphs 28(3) and (4) in Division 8 should be placed at a height of 900mm from the finished floor level and be fixed on both sides and at the rear of the lift car (lift door(s) excepted);
3. Paragraph 5.5 B(a)(ix) in Chapter 5 ²	the maximum travel should be 4000mm;	the maximum travel should be 7000mm;
4. Paragraph 5.5 B(a)(xii) in Chapter 5 ³	The landings to a vertical lifting platforms at the 2 access levels should be in opposite directions so as to eliminate the need for the wheelchair to back-out.	Every landing to a vertical lifting platform should be in opposite direction or located at 90° relative to all other landings so as to eliminate the need for the wheelchair to back-out. This requirement does not apply to a vertical lifting platform which is provided with power-operated and automatically controlled horizontally sliding or swing doors. The kinetic energy of the automatic doors should not exceed 10J.

¹ To unify the standards of control buttons and emergency call button of a vertical lifting platform as an accessible lift.

² To extend the limit of travel height of a vertical lifting platform to 7000mm taking into account current Code of Practice on the Design and Construction of Lifts and Escalators issued by the Electrical and Mechanical Services Department.

³ To control the arrangement on access to and egress from a vertical lifting platform with a maximum travel height up to 7000mm which may serve more than two access levels. Back-out arrangement of the wheelchair is allowed if a vertical lifting platform provided with automatic doors similar to an accessible lift with automatic doors.

Item	2008 version	Amendments
------	--------------	------------

5. Figure 45

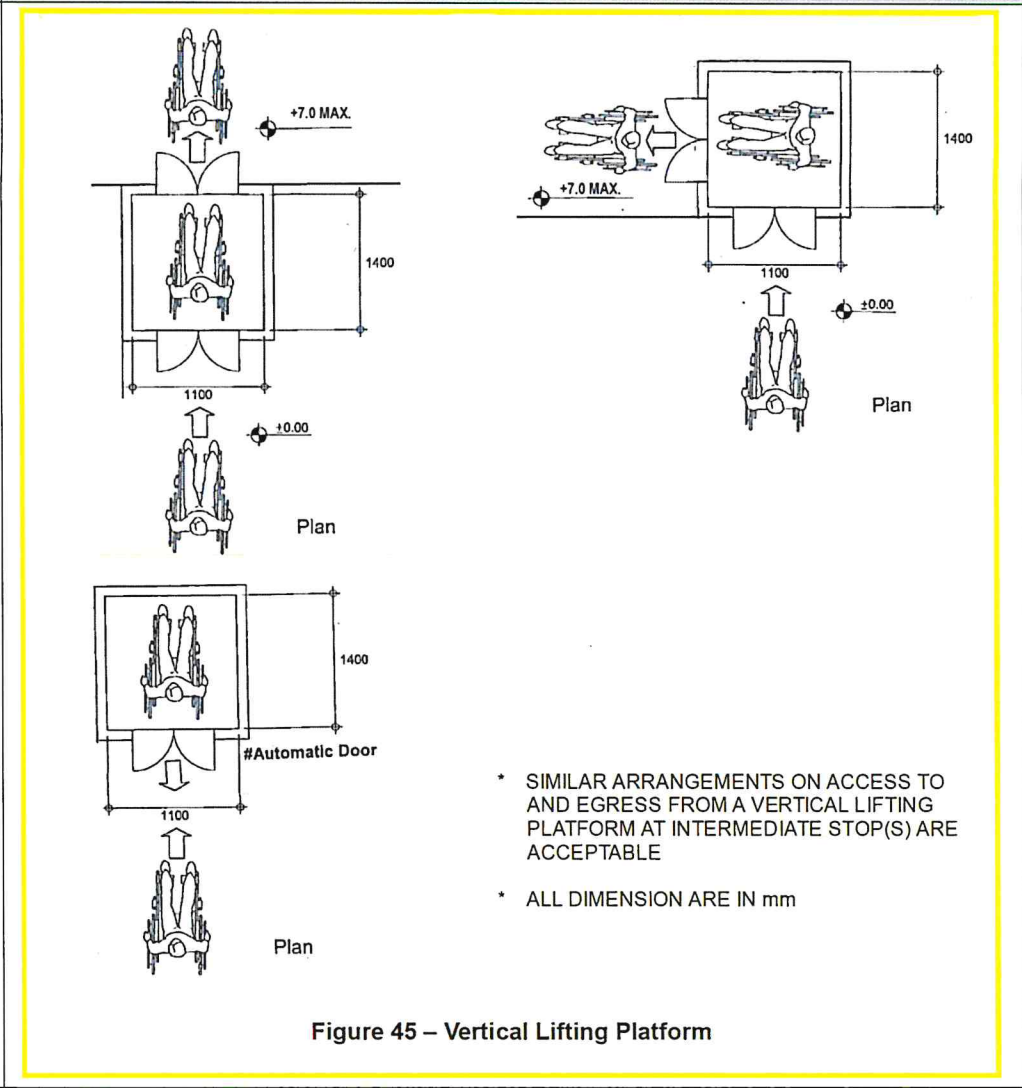
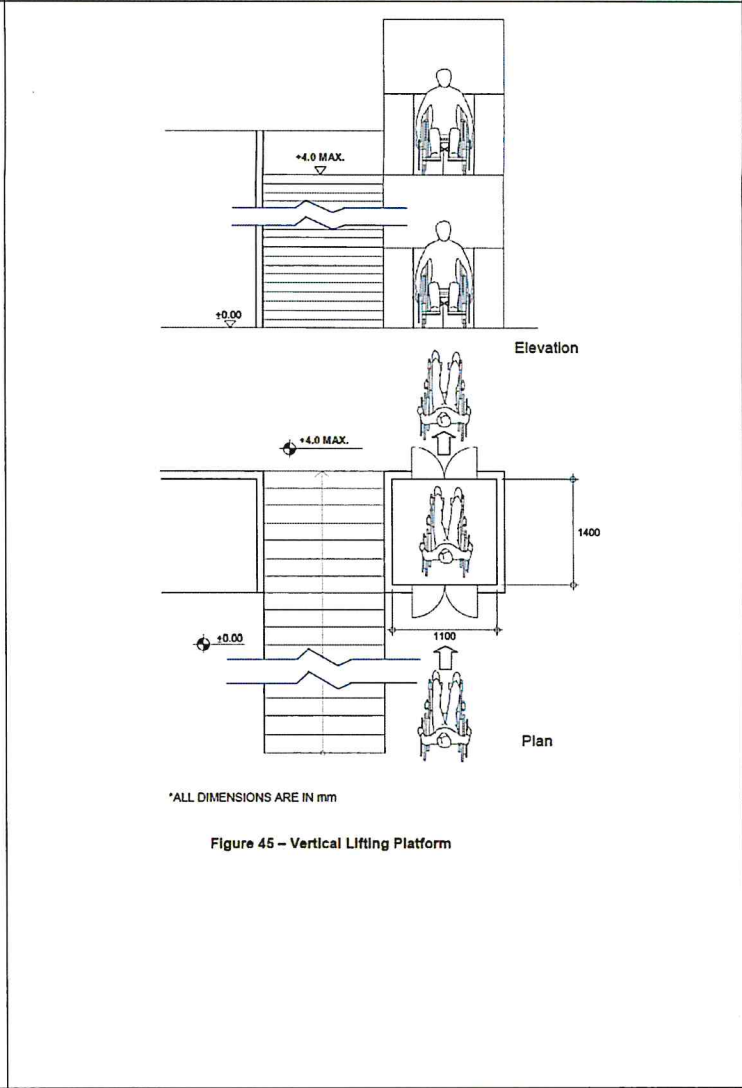

**Summary of Amendments to the Design Manual: Barrier Free Access 2008
(April 2017)**

(A) <i>Obligatory Design Requirements:</i>	
1	Braille and tactile information on handrail (item 1)
2	Fire exit map (item 2)
3	Braille and tactile signs for toilets (items 3 and 4)

(B) <i>Design Considerations and Recommended Design Requirements under Best Practice Section:</i>	
1	Power-operated door for accessible toilets (items 5 to 7)
2	Slip-resistant grab rails and handrails (items 8 to 10)
3	Emergency call bells in accessible bathrooms and shower compartments (items 10 and 13)
4	Revised design of grab rails and shower seats for shower compartments (items 10 to 11)
5	Emergency alarm link to public information or service counter (item 12)
6	Marking for frameless glass doors (item 14)
7	Round edges for counters / devices installed at controlled passages / guardrails under low headroom (item 15)

8	Sliding door at accessible toilet (item 16)
9	Luminous contrast between toilet door/compartment door and wall (item 17)
10	Indicating tiles/blocks to urinal for use by persons with ambulant disabilities (items 18 and 19)
11	Levels of illumination in toilets (items 20 and 21)
12	Staircase not to be at open riser design (item 22)
13	Minimum clearance between directional tiles/blocks and walls (item 23)
14	Visual alarm (items 24 and 25)
15	Further guidelines in providing vertical lifting platform (items 26 to 31)
16	Provisions of audience spaces for wheelchair users, visual display of subtitles and room for “audio description” in auditorium (items 32 and 33)
17	Visual door bells in hotels, hostels and guest houses (item 34)
18	Number of accessible car parking spaces (item 35)

Amendments to the Design Manual: Barrier Free Access 2008

(April 2017)

Legends:



Amended



Deleted

@

Obligatory Design Requirements

#

Design Considerations under Best Practice Section

*

Recommended Design Requirements under Best Practice Section

Item	2012 version	Amendments
<p>1. Figure 16A@</p>	<p>Figure 16A – Handrails of Staircase</p>	<p>Figure 16A – Handrails of Staircase</p> <p>*ALL DIMENSIONS ARE IN mm</p>

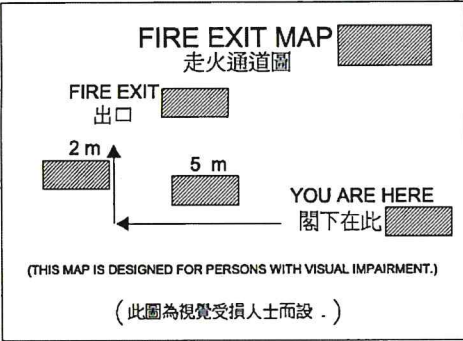
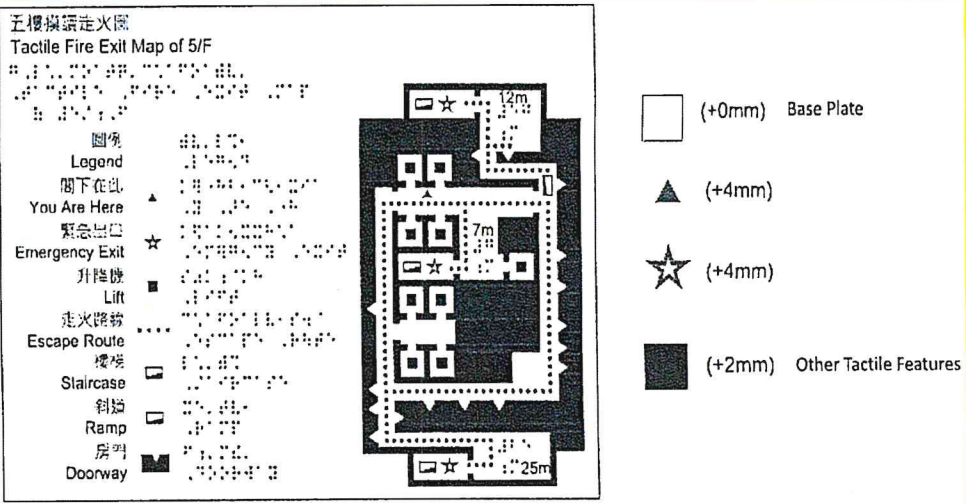
Item	2008 version	Amendments
2. Figure 32@	 <p data-bbox="407 501 824 520">(THIS MAP IS DESIGNED FOR PERSONS WITH VISUAL IMPAIRMENT.)</p> <p data-bbox="497 539 734 564">(此圖為視覺受損人士而設.)</p> <p data-bbox="452 603 1048 641">Note: -> The 2m and 5m as shown on the Map are hypothetical figures only. They shall be subject to actual site condition.</p> <p data-bbox="519 654 721 673">Braille information</p>	
3. Paragraph 68 (1)&(2) in Division 13 of Chapter 4@	<p data-bbox="362 788 1070 1008">Braille and tactile sign shall be installed on adjacent wall or door of public toilet to indicate whether the toilet is for male, female or unisex. The sign shall be placed at 900 mm to 1500 mm above the finished floor level. Specification of Braille cells is shown in Figure 31.</p>	<p data-bbox="1102 788 2092 928">Braille and tactile signs shall be installed on adjacent wall or door of public toilet to indicate whether the toilet is for male, female or unisex. The signs shall be placed between 900 mm to 1500 mm above the finished floor level. Specifications of Braille cells and tactile signs are shown in Figure 31.</p>

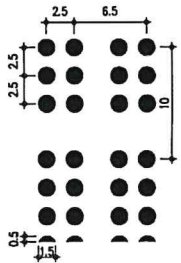
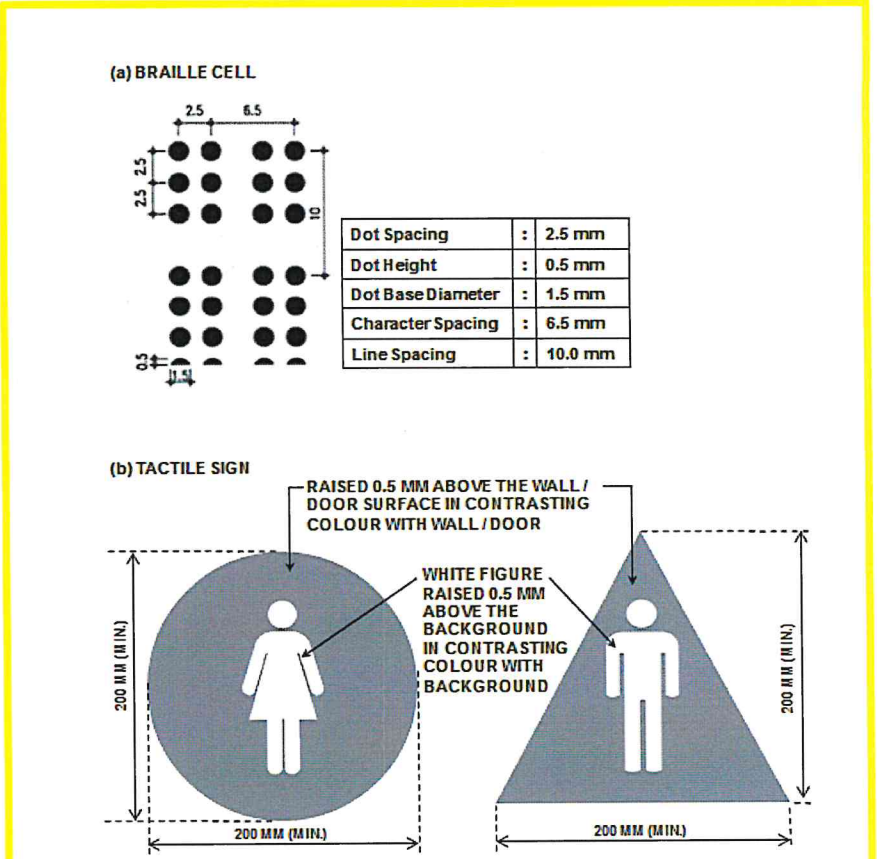
Item	2008 version	Amendments																											
4. Figure 31 in Division 13 of Chapter 4@	 <table border="1" data-bbox="392 510 1030 590"> <tr> <td>Dot Spacing :</td> <td>2.5 mm</td> <td>Character Spacing :</td> <td>6.5 mm</td> </tr> <tr> <td>Dot Height :</td> <td>0.5 mm</td> <td>Line Spacing :</td> <td>10.0 mm</td> </tr> <tr> <td>Dot base diameter :</td> <td>1.5 mm</td> <td></td> <td></td> </tr> </table> <p data-bbox="392 614 739 646">Figure 31 – Specification of Braille Cells</p>	Dot Spacing :	2.5 mm	Character Spacing :	6.5 mm	Dot Height :	0.5 mm	Line Spacing :	10.0 mm	Dot base diameter :	1.5 mm			 <p data-bbox="1254 335 1411 367">(a) BRAILLE CELL</p> <table border="1" data-bbox="1489 494 1780 646"> <tr> <td>Dot Spacing</td> <td>:</td> <td>2.5 mm</td> </tr> <tr> <td>Dot Height</td> <td>:</td> <td>0.5 mm</td> </tr> <tr> <td>Dot Base Diameter</td> <td>:</td> <td>1.5 mm</td> </tr> <tr> <td>Character Spacing</td> <td>:</td> <td>6.5 mm</td> </tr> <tr> <td>Line Spacing</td> <td>:</td> <td>10.0 mm</td> </tr> </table> <p data-bbox="1254 734 1411 766">(b) TACTILE SIGN</p> <p data-bbox="1444 758 1747 813">RAISED 0.5 MM ABOVE THE WALL / DOOR SURFACE IN CONTRASTING COLOUR WITH WALL / DOOR</p> <p data-bbox="1556 845 1724 981">WHITE FIGURE RAISED 0.5 MM ABOVE THE BACKGROUND IN CONTRASTING COLOUR WITH BACKGROUND</p> <p data-bbox="1254 901 1288 997">200 MM (MIN.)</p> <p data-bbox="1377 1109 1489 1133">200 MM (MIN.)</p> <p data-bbox="1915 901 1948 997">200 MM (MIN.)</p> <p data-bbox="1736 1109 1848 1133">200 MM (MIN.)</p> <p data-bbox="1254 1165 1825 1197">Figure 31 – Specifications of Braille Cells and Tactile Signs</p>	Dot Spacing	:	2.5 mm	Dot Height	:	0.5 mm	Dot Base Diameter	:	1.5 mm	Character Spacing	:	6.5 mm	Line Spacing	:	10.0 mm
Dot Spacing :	2.5 mm	Character Spacing :	6.5 mm																										
Dot Height :	0.5 mm	Line Spacing :	10.0 mm																										
Dot base diameter :	1.5 mm																												
Dot Spacing	:	2.5 mm																											
Dot Height	:	0.5 mm																											
Dot Base Diameter	:	1.5 mm																											
Character Spacing	:	6.5 mm																											
Line Spacing	:	10.0 mm																											

Item	2008 version	Amendments
5. Division 11 of Chapter 4#		<p><i>(To add paragraph (da) after paragraph (d) in Section A)</i></p> <p>(da) Power-operated door is considered convenient for persons with a disability, and a power-operated sliding door is preferable to power-operated swing door from safety point of view. The swing path and mechanism of power-operated swing doors should not pose a risk of colliding with passers-by.</p>
6. Division 11 of Chapter 4*		<p><i>(To add paragraph (ea) after paragraph (e) in Section B)</i></p> <p>(ea) A power-operated door should be designed as follows:</p> <ul style="list-style-type: none"> (i) push pad type control buttons having a minimum dimension of 20 mm should be used to open or lock the door; (ii) after the door is open, the door should be automatically closed after a minimum of 10-second time lapse. An audible signal should be provided to signify the door opening and closing action; (iii) a detection device should be provided to re-open the door in the event of hitting any obstacle. The device should be positioned at a height between 300 mm to 400 mm above the finished floor level; (iv) a lock button should be provided inside the toilet. The locking device should be able to be released from the outside manually upon activation of an emergency break glass unit installed between 1800 mm to 2000 mm above the finished floor level outside the toilet. The maximum horizontal force for opening the door manually should comply with the requirements stipulated in paragraph 43 in Division 10;

Item	2008 version	Amendments
6. Division 11 of Chapter 4* (cont'd)		<ul style="list-style-type: none"> <li data-bbox="1211 229 2114 300">(v) in case the lock button is pressed before the door-closing action is complete, the door should still be able to be locked; <li data-bbox="1211 328 2114 399">(vi) an audible message should be provided in English, Cantonese and Putonghua to inform the user after the door is locked; <li data-bbox="1211 427 2114 533">(vii) an indicator activated by the locking device signifying the toilet is being occupied should be provided both inside and outside the toilet; <li data-bbox="1211 561 2114 813">(viii) the door should be provided with vertical grab rails fixed on both sides of the door at the height of 800 mm from the finished floor level (measuring from the bottom of the grab rails) and with a grip space of not less than 30 mm clear of the door. Grab rails should not be less than 32 mm and not more than 40 mm in external diameter and not less than 600 mm in length; <li data-bbox="1211 842 2114 948">(ix) the door including control buttons should have a minimum luminous contrast of 30% with the door frame and their surrounding finishes; <li data-bbox="1211 976 2114 1046">(x) a back-up emergency power supply should be provided for at least 20 minutes in power failure situation; <li data-bbox="1211 1075 2114 1292">(xi) the control buttons should be installed at the wall adjacent to the door opening such that the user will not be interfered by the door movement. For a door swinging into an area with internal corner, the buttons should be located at least 600 mm from the internal corner of a room and the button should have a clear 1000 mm minimum distance from the swing of the door;

Item	2008 version	Amendments
6. Division 11 of Chapter 4*(cont'd)		<p>(xii) the control buttons should be located at not less than 900 mm and not more than 1200 mm above the finished floor level;</p> <p>(xiii) separate door open and lock buttons should be provided inside the toilet and placed together;</p> <p>(xiv) Braille and tactile marking should be provided to the control buttons in compliance with the requirements stipulated in paragraphs 80(5) and 80(6) in Division 19 and Figures 25A and 25B; and</p> <p>(xv) user instructions in Chinese, English and Braille on how to open and lock the door should be provided adjacent to the control buttons inside the toilet.</p> <p>See examples in Figures 25A to 25D.</p>

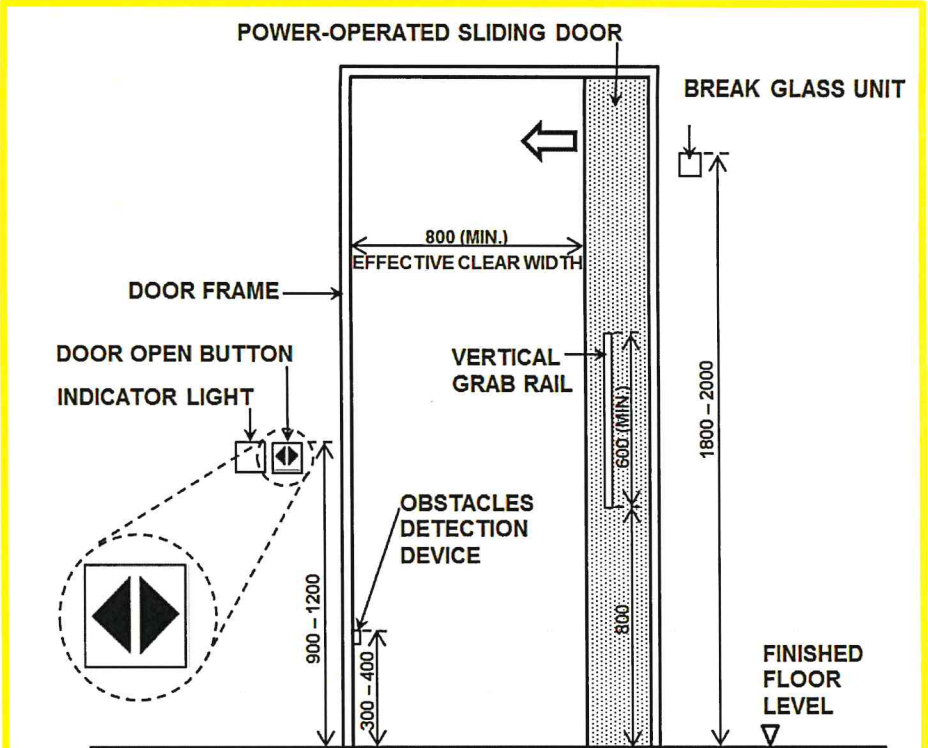
Item	2008 version	Amendments
7. Division 11 of Chapter 4*(cont'd)		<p data-bbox="1099 209 1361 240"><i>(To add Figure 25A)</i></p>  <p data-bbox="1167 1046 1496 1070">* ALL DIMENSIONS ARE IN mm</p> <p data-bbox="1167 1082 1861 1145">Figure 25A - Elevation of Power-operated Sliding Door (View from Outside of Accessible Toilet)</p>

Item	2008 version	Amendments
7. Division 11 of Chapter 4*(cont'd)		<p data-bbox="1122 204 1384 240"><i>(To add Figure 25B)</i></p> <div data-bbox="1144 272 2085 1023" style="border: 2px solid yellow; padding: 10px;"> <p data-bbox="1189 916 1451 938">* ALL DIMENSIONS ARE IN mm</p> <p data-bbox="1182 948 1749 1002">Figure 25B – Elevation of Power-operated Sliding Door (View from Inside of Accessible Toilet)</p> </div>

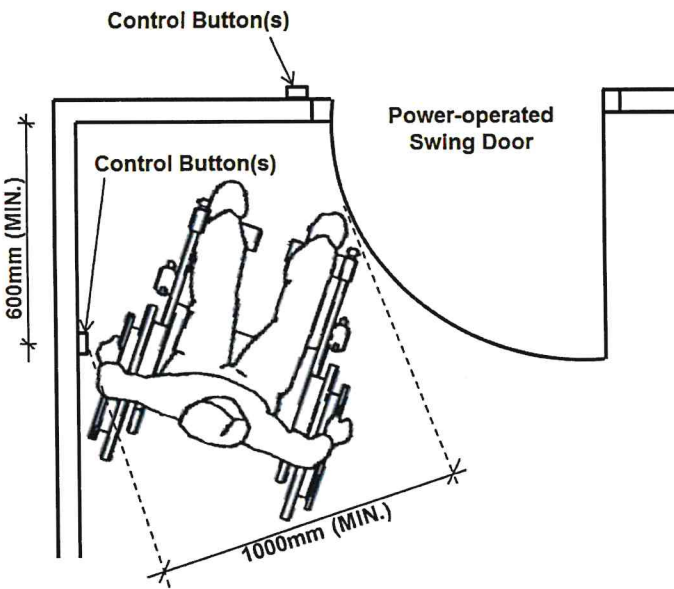
Item	2008 version	Amendments
7. Division 11 of Chapter 4*(cont'd)		<p data-bbox="1084 204 1346 240"><i>(To add Figure 25C)</i></p> <div data-bbox="1093 288 2063 1034" style="border: 2px solid yellow; padding: 10px;">  <p data-bbox="1122 927 2040 954">Figure 25C – Plan of Power-operated Swing Door (Control Button(s) on Separate Walls)</p> </div>

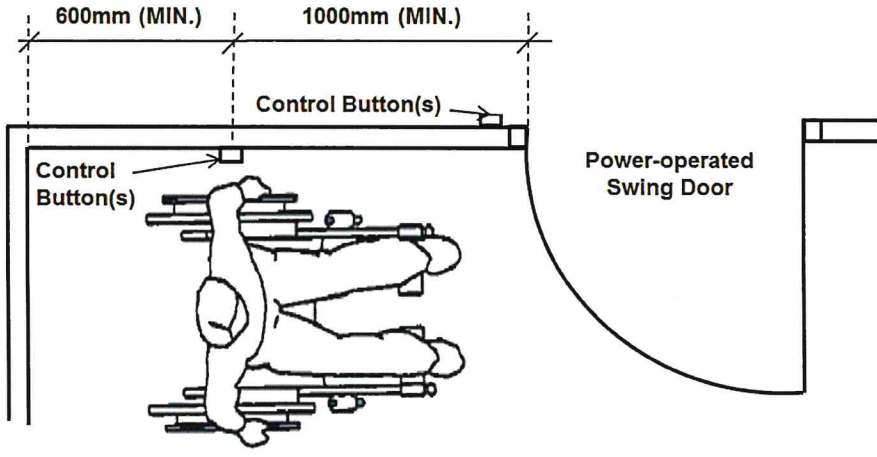
Item	2008 version	Amendments
7. Division 11 of Chapter 4*(cont'd)		<p data-bbox="1111 204 1375 240"><i>(To add Figure 25D)</i></p> <div data-bbox="1115 263 2085 869" style="border: 2px solid yellow; padding: 10px;">  <p data-bbox="1173 783 2056 810">Figure 25D – Plan of Power-operated Swing Door (Control Button(s) on Same Wall)</p> </div>
8. Division 8 of Chapter 4*		<p data-bbox="1111 916 1827 952"><i>(To add paragraph (e) after paragraph (d) in Section B)</i></p> <p data-bbox="1115 975 1301 1011">Slip-resistant</p> <p data-bbox="1115 1034 2107 1107">(e) The surface of the handrails provided under paragraph 28 in Division 8 should be slip-resistant, e.g. stainless steel with hair-line finish.</p>

Item	2008 version	Amendments
9. Division 11 of Chapter 4*		<p><i>(To add a heading and paragraph (m) after paragraph (l) in Section B)</i></p> <p>Grab Rails</p> <p>(m) The surface of the grab rails should be slip-resistant, e.g. stainless steel with hair-line finish.</p>
10. Section B in Division 12*	Taps and other controls should be installed between the centre line and the outer edge of the bathtub.	<p><i>(To designate the existing requirement as paragraph (a) and to add paragraphs (b), (c), (d), (e) and (f) in Section B)</i></p> <p>Taps and Controls</p> <p>(a) Taps and other controls should be installed between the centre line and the outer edge of the bathtub.</p> <p>Grab Rails</p> <p>(b) The surface of the grab rails should be slip-resistant, e.g. stainless steel with hair-line finish.</p> <p>(c) Two additional vertical grab rails should be installed for shower compartments and they should:</p> <ul style="list-style-type: none"> (i) have a minimum length of 750 mm; (ii) be installed at a height between 700 mm and 800 mm measured from the bottom of the bars to the finished floor level; and (iii) be provided adjacent to the shower seat such that one is mounted beside the shower seat and another one is mounted not more than 450 mm from the edge of the shower seat (see Figure 27).

Item	2008 version	Amendments
10. Section B in Division 12*(cont'd)		<p data-bbox="1115 229 1301 261">Shower Seats</p> <p data-bbox="1115 288 2107 325">(d) The depth of shower seats in shower compartments should be 450 mm.</p> <p data-bbox="1115 352 2107 424">Emergency Call Bells in Accessible Bathrooms and Shower Compartments</p> <p data-bbox="1115 451 2107 703">(e) The push button of the emergency call bell should be appropriately located and conveniently accessible to all users. The emergency call bell when activated should emit audible or visible alarm signal which should be readily noticeable for summoning assistance for the person in the bathroom/shower compartment. The emergency alarm should be installed outside the bathroom/shower compartment and connected to a public information or service counter.</p> <p data-bbox="1115 730 2107 951">(f) An emergency call bell should be equipped with a weatherproof push button for activating the alarm. The push button should be installed at the wall outside but immediately adjacent to the bathtub or shower compartment at a height between 400 mm to 600 mm above the finished floor level. A notice “Emergency Call” in English, Chinese and Braille shall be fitted next to the emergency push button.</p>

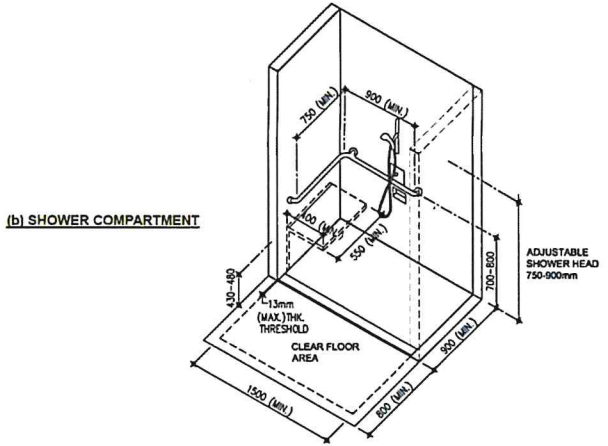
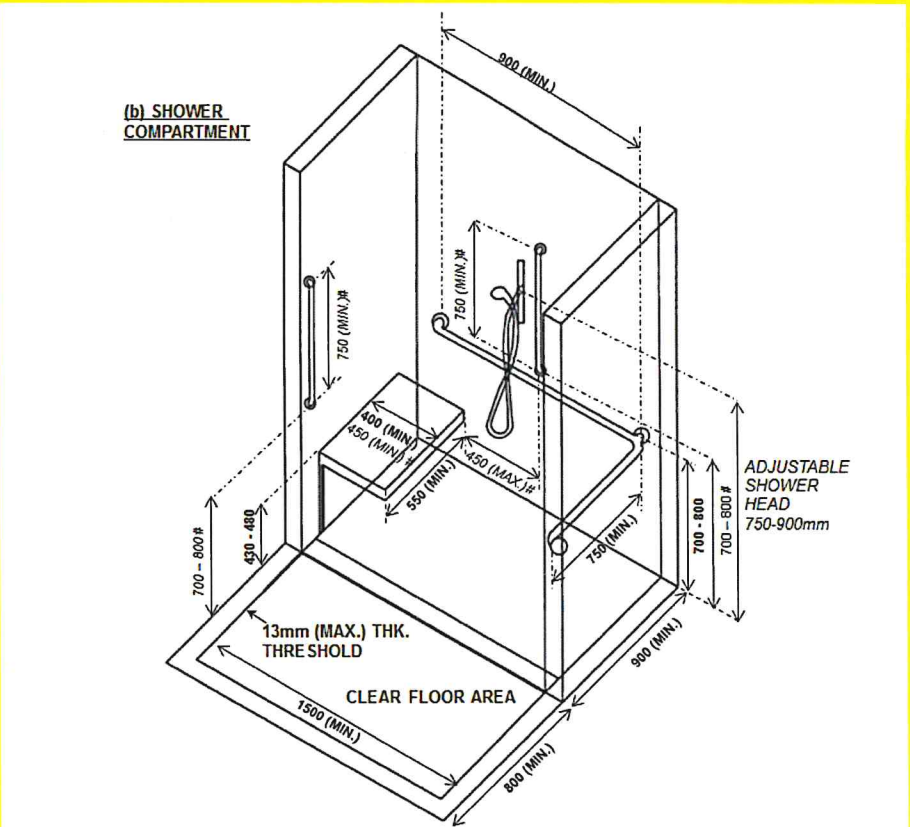
Item	2008 version	Amendments
<p>11. Figure 27 in Division 12 of Chapter 4*</p>	 <p>(b) SHOWER COMPARTMENT</p> <p>*ALL DIMENSIONS ARE IN mm</p> <p>Figure 27 - Example of Bathroom and Shower Compartment</p>	 <p>(b) SHOWER COMPARTMENT</p> <p># VERTICAL GRAB RAILS AND SEAT DEPTH UNDER RECOMMENDED DESIGN REQUIREMENTS</p> <p>* ALL DIMENSIONS ARE IN mm DIMENSIONS PRINTED IN BOLD FORM DENOTE OBLIGATORY DESIGN REQUIREMENTS DIMENSIONS PRINTED IN ITALIC FORM DENOTE RECOMMENDED DESIGN REQUIREMENTS</p> <p>Figure 27 - Examples of Bathroom and Shower Compartment</p>

Item	2008 version	Amendments
12.Paragraph A(b) in Division 17#	In addition to a position outside the compartment or cubicle, the emergency alarm should be connected to a 24-hours manned caretaker's office.	In addition to a position outside the compartment or cubicle, the emergency alarm should be connected to a caretaker's office or public information/service counter provided under paragraph 70 in Division 15.
13.Division 17 of Chapter 4#		<i>(To add paragraph (c) in Section A)</i> Emergency call bells should be equipped with a back-up power supply.
14.Division 10 of Chapter 4*		<i>(To add paragraph (fa) after paragraph (f) in Section B)</i> The marking provided at a frameless glass door should consist of at least a horizontal band with a minimum height of 100 mm and contrasting colours with the background to assist visibility. The marking including those in broken or solid lines, patterns or company logos, etc., should cover at least 10% of the glazing area within the zone between 900 mm and 1500 mm above the internal finished floor. If the horizontal band design is not adopted, other types of marking should still be designed horizontally across the glass door. Such kind of marking should cover at least 30% of the glazing area within the zone between 900 mm and 1500 mm above the internal finished floor.
15.Division 9 of Chapter 4*		<i>(To add a heading and paragraph (i) after paragraph (h) in Section B)</i> Round Edges (i) The counters or devices installed at controlled passages and the warning guardrails provided for low headroom should be designed with round edges.

Item	2008 version	Amendments
16.Paragraph B(e) in Division 11*	Double swing doors which open both inwards and outwards may be provided in any toilets or cubicles. Sliding door is equally acceptable provided that it is not heavy or awkward to use.	Double swing doors which open both inwards and outwards may be provided in any toilets or cubicles. Sliding door fixed with vertical grab rails on both sides of the door in accordance with paragraph (ea) (viii) below is equally acceptable provided that it is not heavy or awkward to use. The requirements of door handle and horizontal grab rail will not be applicable to sliding doors.
17.Division 11 of Chapter 4*		<p><i>(To add paragraph (ha) after paragraph (h) in Section B)</i></p> <p>(ha) Toilet door and compartment door should have a minimum luminous contrast of 30% with its frame and adjacent wall.</p>
18.Division 11 of Chapter 4*		<p><i>(To add a heading and paragraphs (n) and (o) after paragraph (m) in Section B)</i></p> <p>Indicating Tiles/Blocks</p> <p>(n) Two indicating tiles/blocks on the floor to facilitate the use by persons with visual impairment (see Figures 26A and 26B) should be provided in front of the urinal for use by persons with ambulant disabilities.</p> <p>(o) The indicating tiles/blocks should have a minimum luminous contrast of 30% with the floor finishes.</p>

Item	2008 version	Amendments
------	--------------	------------

19.Division 11
of Chapter
4*

(To add Figures 26A and 26B)

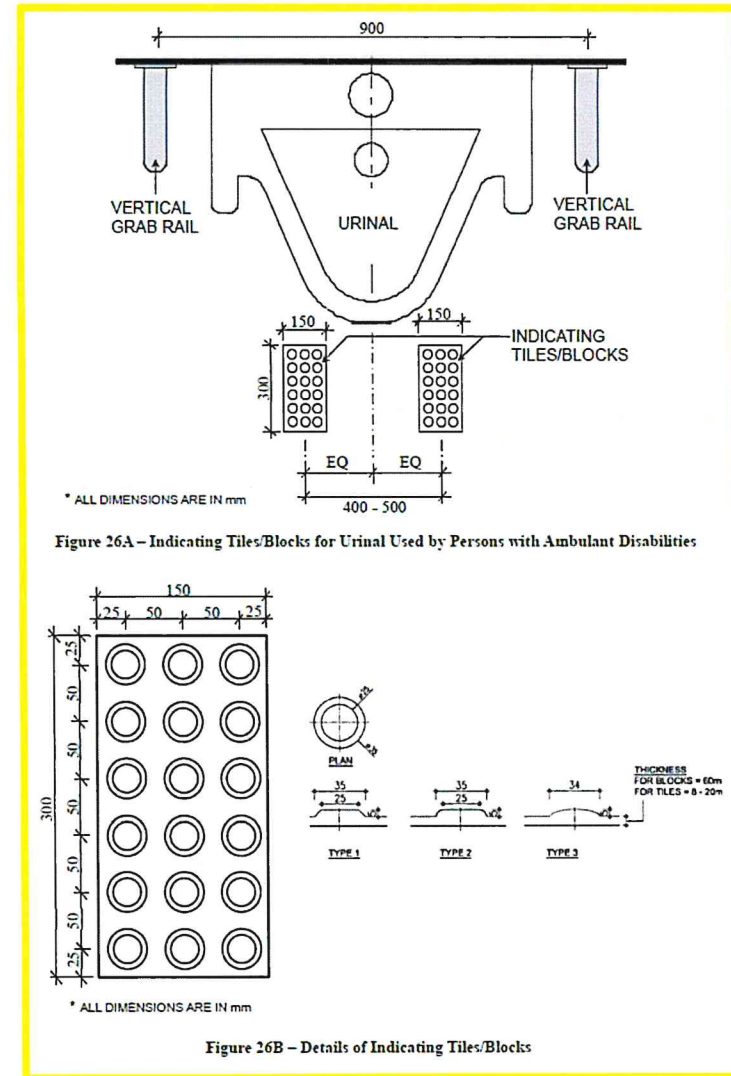

Figure 26A – Indicating Tiles/Blocks for Urinal Used by Persons with Ambulant Disabilities

Figure 26B – Details of Indicating Tiles/Blocks

Item	2008 version	Amendments										
20.Paragraph B(a) in Division 16*	Common areas of a building should have an illumination level of not less than 120 lux measured at the finished floor level.	Common areas, including toilets, of a building should have an illumination level of not less than 120 lux measured at the finished floor level.										
21.Paragraph B(c) in Division 16*	Uniformity of illumination level should be maintained throughout the designated confined areas such as staircases, corridors or the like.	Uniformity of illumination level should be maintained throughout the designated areas and toilets.										
22.Paragraph A(f) in Division 7#	Stair should be designed with more generous dimensions, e.g. wider tread, and shorter travel distance is recommended. Open risers should be avoided.	Stair should be designed with more generous dimensions, e.g. wider tread, and shorter travel distance is recommended. No open risers shall be installed.										
23.Division 4 of Chapter 4*		<p><i>(To add a heading and paragraph (d) after paragraph (c) in Section B)</i></p> <p>Directional Tiles/Blocks</p> <p>(d) A minimum clearance between directional tiles/blocks of tactile guide path and an obstruction should be maintained as follows:</p> <table border="1" data-bbox="1144 995 2067 1294"> <thead> <tr> <th>Clear Width of Access Route</th> <th>Minimum Clearance</th> </tr> </thead> <tbody> <tr> <td>1050 mm – less than 1200 mm</td> <td>350 mm</td> </tr> <tr> <td>1200 mm – less than 1350 mm</td> <td>450 mm</td> </tr> <tr> <td>1350 mm – less than 1500 mm</td> <td>500 mm</td> </tr> <tr> <td>1500 mm or above</td> <td>600 mm</td> </tr> </tbody> </table>	Clear Width of Access Route	Minimum Clearance	1050 mm – less than 1200 mm	350 mm	1200 mm – less than 1350 mm	450 mm	1350 mm – less than 1500 mm	500 mm	1500 mm or above	600 mm
Clear Width of Access Route	Minimum Clearance											
1050 mm – less than 1200 mm	350 mm											
1200 mm – less than 1350 mm	450 mm											
1350 mm – less than 1500 mm	500 mm											
1500 mm or above	600 mm											

Item	2008 version	Amendments
24.Paragraph 5.2.3(b) in Chapter 5@	The provision of visual alarm shall not apply to all exit staircases as required under the Code of Practice for the Provision of Means of Escape in Case of Fire including the smoke lobbies adjoining the exit staircase, and the following areas: -	The provision of visual alarm shall not apply to all exit staircases as required under the Code of Practice for Fire Safety in Buildings including the smoke lobbies adjoining the exit staircase, and the following areas: -
25.Paragraph 5.2 in Chapter 5*		<p><i>(To add Section B after Section A)</i></p> <p>B. Recommended Design Requirements</p> <p>Except for areas designed for domestic use, areas listed in paragraph 5.2.3(b) shall also be provided with visual alarm in situations where person with hearing impairment has to work alone.</p>
26.Paragraph 5.5 B(a)(ii) and (iii) in Chapter 5*	<p>Door</p> <p>(i) minimum clear entrance width of 900 mm;</p> <p>(ii) Single door or 2-door design;</p> <p>Platform size</p> <p>(iii) minimum size of 1100 mm (wide) x 1400 mm (deep);</p>	<p>Automatic Door</p> <p>(i) minimum clear entrance width of 900 mm;</p> <p>(ii) single door or 2-door design and the kinetic energy of the door should not exceed 10J;</p> <p>Platform size</p> <p>(iii) minimum size of 1100 mm (wide) x 1500 mm (deep);</p>

Item	2015 version	Amendments
27.Paragraph 5.5 B(a)(vi) in Chapter 5*	<p>Control</p> <p>(vi) lift buttons and emergency call buttons should comply with paragraphs 80(1) to 80(8) and 80(i) and 80(ii) in Division 19;</p>	<p>Control</p> <p>(vi) lifting platform buttons and emergency call buttons should comply with paragraphs 80(1) to 80(8) and 80(i) and 80(ii) in Division 19. For automatic swing doors, the control buttons at the landing side should meet the requirements in paragraph (ea)(xi) in Section B of Division 11. The hold-to-run button should be of a minimum dimension of 50 mm;</p> <p>(viA) the vertical lifting platform should be self-operable by users holding a common key;</p> <p>(viB) call button and CCTV should be provided at every landing to a vertical lifting platform. The call button should activate an intercom and video contact with a caretaker's office or public information/service counter provided under paragraph 70 in Division 15 for assistance;</p>
28.Paragraph 5.5 B(a)(viii) in Chapter 5*	<p>Grab bars</p> <p>(viii) grab bars complying with paragraphs 28(3) and (4) in Division 8 should be placed at a height of 900 mm from the finished floor level and be fixed on both sides and at the rear of the lift car (lift door(s) excepted);</p>	<p>Grab Bars</p> <p>(viii) grab bars complying with paragraphs 28(3) and (4) in Division 8 should be placed at a height of 900 mm from the finished floor level and be fixed on both sides and at the rear of the platform (door(s) excepted). The vertical distance between the grab bar and the control buttons should not be less than 100 mm;</p>

Item	2015 version	Amendments
29.Paragraph 5.5 B(a)(xii) in Chapter 5*	<p>Landing</p> <p>(xii) Every landing to a vertical lifting platform should be in opposite direction or located at 90° relative to all other landings so as to eliminate the need for the wheelchair to back-out. This requirement does not apply to a vertical lifting platform which is provided with power-operated and automatically controlled horizontally sliding or swing doors. The kinetic energy of the automatic doors should not exceed 10J.</p>	<p>(xii) (repealed in April 2017)</p>

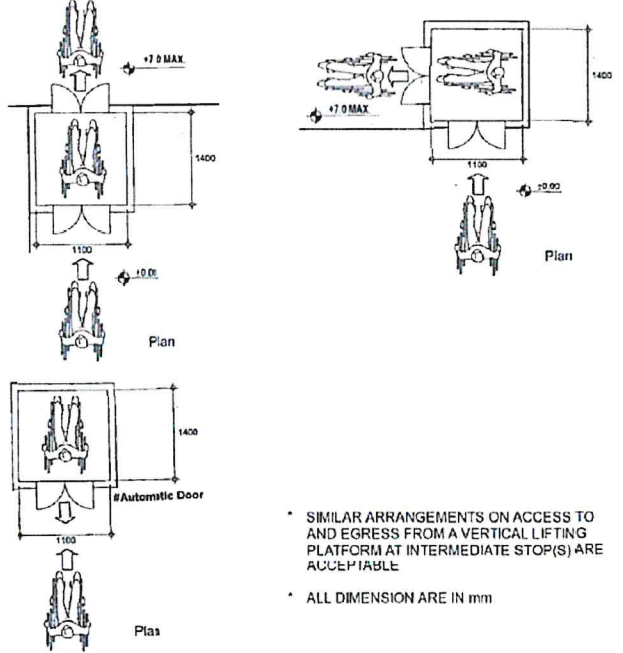
Item	2015 version	Amendments
<p>30.Paragraph 5.5 B(a) and Figure 45 in Chapter 5*</p>	<p>(a) Where it is impractical to provide a passenger lift or a ramp, a self-operated vertical lifting platform should be considered as a reasonable alternative for vertical circulation for wheelchair users, the vertical lifting platform should have the following provisions (see Figure 45):-</p>  <p>* SIMILAR ARRANGEMENTS ON ACCESS TO AND EGRESS FROM A VERTICAL LIFTING PLATFORM AT INTERMEDIATE STOP(S) ARE ACCEPTABLE</p> <p>* ALL DIMENSION ARE IN mm</p> <p>Figure 45 – Vertical Lifting Platform</p>	<p>(a) Where it is impractical to provide a passenger lift or a ramp, a self-operated vertical lifting platform should be considered as a reasonable alternative for vertical circulation for wheelchair users, the vertical lifting platform should have the following provisions:-</p> <p>Figure 45 (repealed in April 2017)</p>

Item	2008 version	Amendments
31.Paragraph 5.5 B(a) in Chapter 5*		<p><i>(To add paragraphs (xiii) after paragraph (xii) in Section B)</i></p> <p>Undertaking from Owners</p> <p>(xiii) the owner should undertake quality management and maintenance to facilitate the reliable use of the lifting platform. The platform should be kept in service during the opening hours of the premises and routine servicing/repair should be arranged in closed times.</p>
32.Division 1 of Chapter 4*		<p><i>(To add paragraphs (g), (h) and (i) after paragraph (f) in Section B)</i></p> <p>(g) Eight wheelchair spaces should be provided at spectator levels in an auditorium with not more than 800 fixed seats. For auditorium with more than 800 fixed seats, four wheelchair spaces should be provided for every additional 400 fixed seats and any part thereof.</p> <p>(h) Visual display of subtitles should be provided at an appropriate location.</p> <p>(i) A room with a view of the performance for “audio description” should be provided for the visually impaired persons.</p>
33.Paragraph B(d) in Division 1 of Chapter 4*	Two to three rows of removable seats should be provided in the auditorium for the use by large group of wheelchair users for special function / occasions.	<p>Removable seats should be provided at accessible spectator levels in an auditorium for the use by large group of wheelchair users for special functions / occasions. Adequate numbers of removable seats to accommodate sixteen wheelchair spaces should be provided in the auditorium with not more than 800 fixed seats. For the auditorium with more than 800 fixed seats, adequate numbers of removable seats to accommodate eight wheelchair spaces should be provided for every additional 400 fixed seats and any part thereof.</p>

Item	2008 version	Amendments										
34.Division 2 of Chapter 4*	A typical guest room layout is shown in Figure 2 and typical bathroom and shower compartment are shown in Figure 27.	<p><i>(To add paragraph (b) after paragraph (a) in Section B)</i></p> <p>(a) A typical guest room layout is shown in Figure 2 and typical bathroom and shower compartment are shown in Figure 27.</p> <p>(b) A minimum of two guest rooms (being not accessible guest rooms) for every 100 guest rooms and any part thereof should be provided with visual door bells installed at a prominent location and the function can be switched on or off conveniently by the guest.</p>										
35.Division 3 of Chapter 4*		<p><i>(To add paragraph (c) after paragraph (b) in Section B)</i></p> <p>(c) Accessible car parking spaces should be provided as follow:</p> <table border="1" data-bbox="1093 730 1928 1010"> <thead> <tr> <th>Total No. of Car Parking Space in Lot</th> <th>No. of Accessible Car Parking Spaces</th> </tr> </thead> <tbody> <tr> <td>1-25</td> <td>1</td> </tr> <tr> <td>26-50</td> <td>2</td> </tr> <tr> <td>51-100</td> <td>3</td> </tr> <tr> <td>for each additional increment of 100 or part thereof</td> <td>one additional space</td> </tr> </tbody> </table>	Total No. of Car Parking Space in Lot	No. of Accessible Car Parking Spaces	1-25	1	26-50	2	51-100	3	for each additional increment of 100 or part thereof	one additional space
Total No. of Car Parking Space in Lot	No. of Accessible Car Parking Spaces											
1-25	1											
26-50	2											
51-100	3											
for each additional increment of 100 or part thereof	one additional space											

**Summary of Amendments to the Design Manual: Barrier Free Access 2008
(June 2019)**

<i>Design Considerations and Recommended Design Requirements under Best Practice Section:</i>	
1	Braille and tactile information for lockers (item 1)
2	Braille characters both in Chinese and English (item 2)
3	Lift control buttons of accessible lift cars (items 3 and 4)
4	Detection device of accessible lift cars (item 5)
5	Increasing depth of accessible lift cars (item 6)
6	Audio and visual indicators in lift cars (item 7)
7	Communication system in lift cars (item 8)
8	Typical layout of guestroom in hotels, hostels and guesthouses (item 9)
9	Hold-open device for fire-rated doors (item 10)
10	Width of door (item 10)
11	Washroom accessories in accessible toilet (item 11)
12	Mirror for wheelchair users at accessible toilet (item 12)
13	Audible and visible alarm signal for emergency call bells (item 13)
14	Public information or service counters (item 14)
15	Baby care room (item 15)
16	Drinking fountains (item 16)

Amendments to the Design Manual: Barrier Free Access 2008

(June 2019)

Legends:

 Amended

 Deleted

Design Considerations under Best Practice Section

* Recommended Design Requirements under Best Practice Section

Item	2008 version	Amendments
1. Division 13 of Chapter 4#*		<p><i>(To add Sections A and B after Figure 32 for paragraph 68)</i></p> <p>BEST PRACTICE SECTION</p> <p>A. Design Considerations</p> <p>Persons with visual impairment may have difficulty in identifying their lockers for public use.</p> <p>B. Recommended Design Requirements</p> <p>Each locker door in sports complex, public swimming pool complex or public areas should be provided with Braille cells and raised Arabic numerals/characters*.</p> <p>* The locker key holders should be provided with raised Arabic numerals/characters.</p>
2. Section A in Division 14 of Chapter 4#		<p><i>(To add paragraph (g) after paragraph (f) in Section A)</i></p> <p>(g) Braille Characters in both English and Chinese should be provided on signs as far as possible if space could accommodate them.</p>
3. Section A following paragraph 80 of Division 19 of Chapter 4#		<p><i>(To add paragraph (ba) after paragraph (b) in Section A)</i></p> <p>(ba) Keypad control device should be avoided as far as practicable.</p>

Item	2008 version	Amendments
4. Section B following paragraph 80 of Division 19 of Chapter 4*		<p><i>(To add paragraphs (ba) and (bb) after paragraph (b) in Section B)</i></p> <p>(ba) In addition to the essential lift control buttons required under paragraph 80(1), another set of essential lift control buttons should be installed on one of the side walls of lift car, preferably in the middle and on the right side from the entering direction. For two lift door openings design, the additional set of essential lift control buttons should be on any side wall.</p> <p>(bb) Lift control buttons in lift cars should have a minimum luminous contrasts of 50% with the background surfaces.</p>
5. Section B following paragraph 80 of Division 19 of Chapter 4*		<p><i>(To add paragraph (g) after paragraph (f) in Section B)</i></p> <p>(g) An additional detection device positioned at a height of 200 mm above the floor of the lift car should be provided.</p>
6. Section B following paragraph 80 of Division 19 of Chapter 4*		<p><i>(To add a heading and paragraph (h) after paragraph (g) added in item 5 above)</i></p> <p>Depth of Accessible Lift Car</p> <p>(h) The clear depth of an accessible lift car should be not less than 1 500 mm.</p>

Item	2008 version	Amendments
7. Section A following paragraph 83 of Division 19 of Chapter 4#	<p>A. Design Considerations</p> <p>Signs indicating the location of an accessible lift should be clearly visible from the main entrance of the building. Additionally, a sign identifying the floor reached should be provided on each landing in a location that can be easily seen from the lift and is designed in luminous contrasts with its surroundings.</p>	<p><i>(To designate the existing requirement as paragraph (a) and to add paragraph (b) in Section A)</i></p> <p>A. Design Considerations</p> <p>(a) Signs indicating the location of an accessible lift should be clearly visible from the main entrance of the building. Additionally, a sign identifying the floor reached should be provided on each landing in a location that can be easily seen from the lift and is designed in luminous contrasts with its surroundings.</p> <p>(b) The audio indication of the stopping floor should be clear and without background noise.</p>
8. Section B following paragraph 83 of Division 19 of Chapter 4*		<p><i>(To add headings and paragraphs (c), (d) and (e) after paragraph (bb) in Section B)</i></p> <p>Indication in Lift Cars</p> <p>(c) The visual indicators and audio indication required under paragraph 82 should be provided in all other passenger lift cars.</p> <p>(d) The voice for audio indication in passenger lifts should be more than 10 dB and should not be more than 80 dB above ambient level, measured at the annunciator. The voice should have a frequency between 300 Hz and 3 000 Hz.</p> <p>Visual Communication System</p> <p>(e) A visual communication system such as the provision of monitor for video call in the lift car should be provided to all passenger lifts to assist persons with hearing impairment in lift car to communicate with the building management office or the caretaker's office in emergency situation.</p>

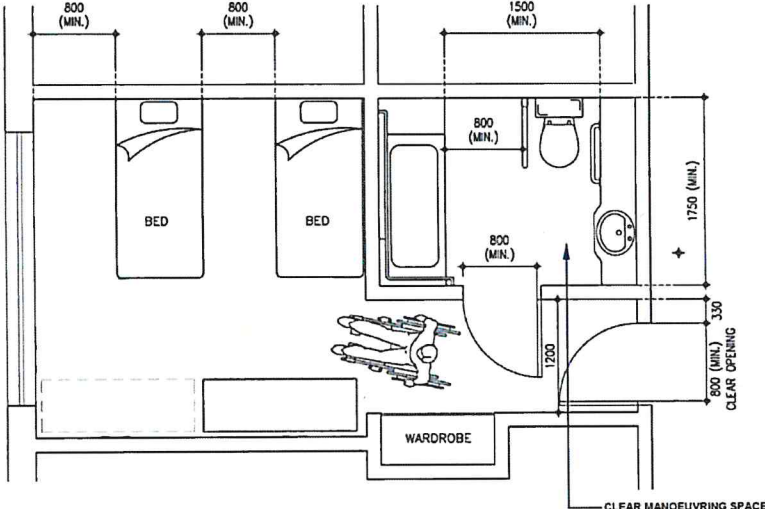
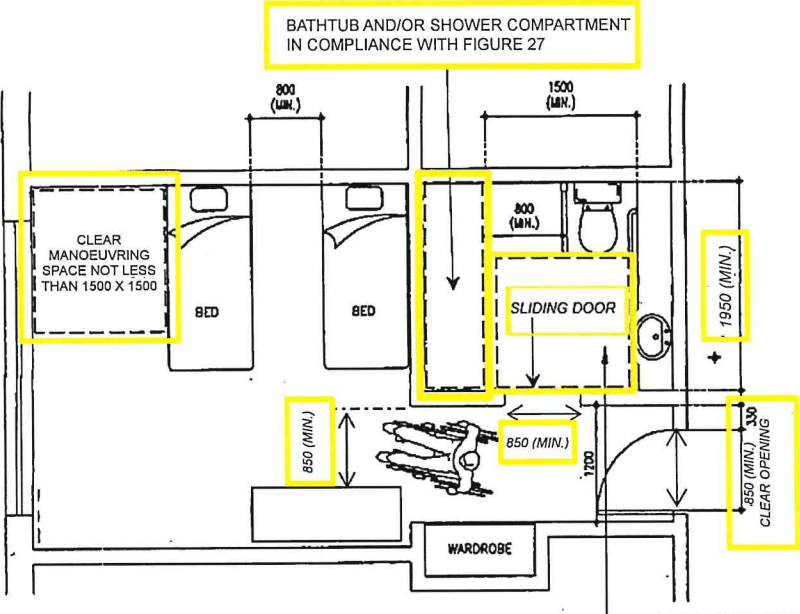
Item	2008 version	Amendments
9. Figure 2 in Division 2 of Chapter 4*	 <p data-bbox="353 880 586 896">*ALL DIMENSIONS ARE IN mm</p> <p data-bbox="952 865 1124 922">CLEAR MANOEUVRING SPACE SHALL NOT BE LESS THAN 1500x1500 MEASURED AT 350 ABOVE FINISHED FLOOR LEVEL</p> <p data-bbox="430 938 797 960">Figure 2 – Typical Guest Room Layout</p>	 <p data-bbox="1518 274 1863 316">BATHTUB AND/OR SHOWER COMPARTMENT IN COMPLIANCE WITH FIGURE 27</p> <p data-bbox="1258 434 1406 603">CLEAR MANOEUVRING SPACE NOT LESS THAN 1500 X 1500</p> <p data-bbox="1729 555 1863 577">SLIDING DOOR</p> <p data-bbox="1505 673 1585 746">800 (MIN.)</p> <p data-bbox="1751 657 1818 689">1500 (MIN.)</p> <p data-bbox="1930 497 1975 587">1950 (MIN.)</p> <p data-bbox="1527 673 1572 746">850 (MIN.)</p> <p data-bbox="1729 689 1796 715">850 (MIN.)</p> <p data-bbox="1953 657 1998 746">850 (MIN.)</p> <p data-bbox="1953 673 1998 746">300 CLEAR OPENING</p> <p data-bbox="1863 874 2033 932">CLEAR MANOEUVRING SPACE SHALL NOT BE LESS THAN 1500x1500 MEASURED AT 350 ABOVE FINISHED FLOOR LEVEL</p> <p data-bbox="1236 954 1469 970">*ALL DIMENSIONS ARE IN mm</p> <p data-bbox="1317 1018 1684 1040">Figure 2 – Typical Guest Room Layout</p>

Item	2008 version	Amendments
10. Section B in Division 10 of Chapter 4*		<p data-bbox="1106 252 2092 325"><i>(To add headings and paragraphs (h) and (i) after paragraph (g) in Section B)</i></p> <p data-bbox="1106 354 1653 386">Doors to Areas with Accessible Facilities</p> <p data-bbox="1106 414 2092 593">(h) Fire rated doors leading to areas with accessible facilities should be provided with hold-open device except for doors to a required staircase forming part of a protected exit and its protected lobby. Doors not for fire safety purposes leading to areas with accessible facilities should be automatic.</p> <p data-bbox="1106 622 1321 654">Width of Doors</p> <p data-bbox="1106 683 2092 788">(i) Door, including one leaf of a double-leaf door, should have a clear width of not less than 850 mm between the open door and opposite jamb or the other leaf.</p>
11. Section B in Division 11 of Chapter 4*		<p data-bbox="1106 823 2020 855"><i>(To add a heading and paragraph (p) after paragraph (o) in Section B)</i></p> <p data-bbox="1106 884 1420 916">Washroom Accessories</p> <p data-bbox="1106 944 2092 1050">(p) The manually operated controls of washroom accessories should be at a position which is not higher than 1 100 mm above the finished floor level.</p>

Item
12. Figure 24 in
Division 11
of
Chapter 4*

2012 version

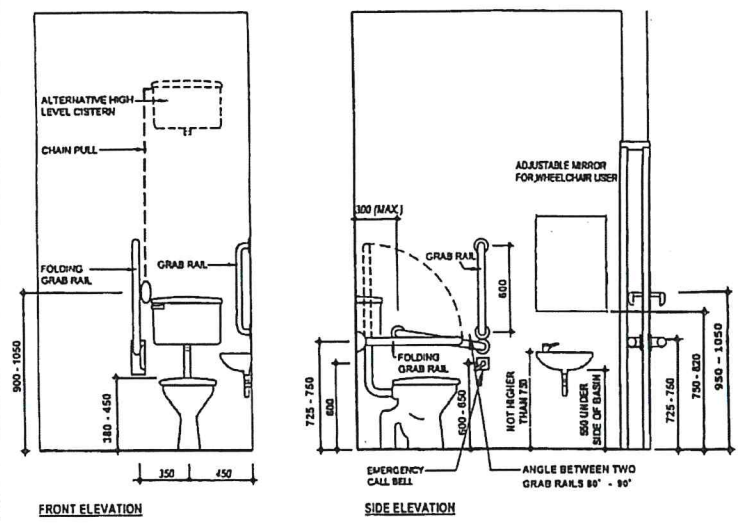

*ALL DIMENSIONS ARE IN mm
 DIMENSIONS PRINTED IN BOLD FORM DENOTE OBLIGATORY REQUIREMENT
 DIMENSIONS PRINTED IN ITALIC FORM DENOTE RECOMMENDED REQUIREMENT

(Opposite - Handed Layout is Acceptable)

Figure 24 - Accessible Toilet

Amendments

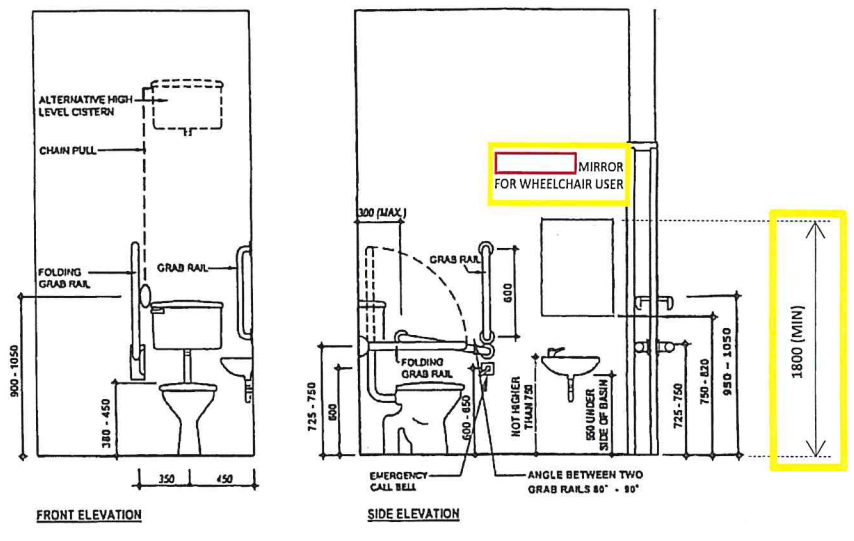

*ALL DIMENSIONS ARE IN mm
 DIMENSIONS PRINTED IN BOLD FORM DENOTE OBLIGATORY REQUIREMENT
 DIMENSIONS PRINTED IN ITALIC FORM DENOTE RECOMMENDED REQUIREMENT

(Opposite - Handed Layout is Acceptable)

Figure 24 - Accessible Toilet

Item	2008 version	Amendments
13.Division 17 of Chapter 4*		<p><i>(To add Section B after Section A)</i></p> <p>B. Recommended Design Requirements</p> <p>(a) The emergency call bell when activated should emit audible and visible alarm signal which should be readily noticeable for summoning assistance.</p> <p>(b) Visible and audible signal should be emitted inside the accessible toilet when the emergency call bell is activated.</p>
14.Division 15 of Chapter 4*		<p><i>(To add Section B after Section A)</i></p> <p>B. Recommended Design Requirements</p> <p>Leg space of a depth between 480 mm to 600 mm should be provided for public information or service counters.</p>
15. Section B in Division 11 of Chapter 4*		<p><i>(To add a heading and paragraph (fa) after paragraph (f) in Section B)</i></p> <p>Baby Care Room</p> <p>(fa) The room should be provided with a clear manoeuvring space not less than 1 500 mm x 1 500 mm measured at 350 mm above finished floor level.</p>
16.Section B in paragraph 5.6 of Chapter 5*		<p><i>(To add paragraph (d) (iv) and (v) after paragraph (d)(iii) in Section B)</i></p> <p>Control</p> <p>(d) Controls should: -</p> <ul style="list-style-type: none"> (i) be at or near to the front of the fountain; (ii) be operable with one hand; and (iii) require no tight grasping, pinching, or twisting of the wrist; (iv) require a force of 22N or less to activate; and (v) be hand-operated control with minimum dimension of 50 mm.

Summary of Amendments to the Design Manual: Barrier Free Access 2008
(October 2020)

<i>Design Considerations and Recommended Design Requirements under Best Practice Section</i>	
1	Braille and tactile information for room numbers and fire exit maps at guest rooms in hotels, hostels and guesthouses (item 1)
2	Resting places for long corridors or passageways (items 2 and 3)
3	Automatic doors for all main entrances (item 4)
4	Unobstructed area adjacent to the door handle on the leading face of a single door (item 5)
5	Bevelled edge of door threshold (item 6)
6	Height of shower head (item 7)
7	Braille and tactile plan of toilet and changing room (item 8)
8	Tactile guide path for office building, hotel, guesthouse, hostel and bank (item 9)
9	Position of the Braille and tactile sign for the public toilet (item 10)
10	Increase in the illumination level for lift lobbies of upper floors, corridors, accessible paths and staircases (items 11 and 12)
11	Mirror in accessible lift car (item 13)

Amendments to the Design Manual: Barrier Free Access 2008

(October 2020)

Legends:

 Amended

 Deleted

Design Considerations under Best Practice Section

* Recommended Design Requirements under Best Practice Section

Item	2017 version	Amendments
<p>1. Section B in Division 2 of Chapter 4*</p>	<p>(b) A minimum of two guest rooms (being not accessible guest rooms) for every 100 guest rooms and any part thereof should be provided with visual door bells installed at a prominent location and the function can be switched on or off conveniently by the guest.</p>	<p>(b) For every 100 guest rooms and any part thereof, in addition to accessible guest rooms, the following types of guest rooms should be provided:</p> <p>(i) A minimum of two guest rooms with visual door bells installed at a prominent location and the function can be switched on or off conveniently by the guest; and</p> <p>(ii) A minimum of two guest rooms located near lift lobby with Braille and tactile fire exit maps at the back of guest room doors, and Braille and tactile information for main lamp switch controls.</p> <p>(c) Where planning allows, the accessible guest rooms required under paragraph 7(2) of Division 2 should be provided with the facilities in paragraph (b)(i) and (ii) above in full or in combination.</p> <p>(d) Where planning allows, the guest rooms in paragraph (b)(i) above should be provided with the facilities for accessible guest rooms in paragraph 7(2) of Division 2 and facilities in paragraph (b)(ii) above in full or in combination.</p> <p>(e) Where planning allows, the guest rooms in paragraph (b)(ii) above should be provided with the facilities for accessible guest rooms in paragraph 7(2) of Division 2 and facilities in paragraph (b)(i) above in full or in combination.</p> <p>(f) For floors with guest rooms provided under paragraph (b)(ii) above, Braille sign should be installed on the wall adjacent to the open side of each door leading to an exit staircase to indicate such information. The sign should be placed at 900 mm to 1500 mm above the finished floor level.</p>

Item	2008 version	Amendments
1. Section B in Division 2 of Chapter 4* (cont'd)		(g) A sign with guest room number in raised Arabic numerals/characters and Braille should be installed on the wall adjacent to the door lock of all guest rooms. The sign should be placed at 900 mm to 1500 mm above the finished floor level.
2. Section A in Division 9 of Chapter 4#		<p><i>To add paragraph (e) after paragraph (d) in Section A</i></p> <p>(e) Long corridors and passageways are difficult for the persons with locomotion impairment to negotiate. Therefore, adequate resting places with resting facilities should be provided therein. Such resting facilities should not reduce the statutory requirements on the clear width of access and manoeuvring space and should not cause obstruction to access, circulation and exit routes.</p>
3. Section B in Division 9 of Chapter 4*		<p><i>To add a heading and paragraph (j) after paragraph (i) in Section B</i></p> <p>Resting Places</p> <p>(j) Seats (including fold-down seats) or lean-on railings should be provided in recessed areas at maximum intervals of 50 m in:</p> <ul style="list-style-type: none"> (i) long corridors and passageways within transport stations, interchanges and passenger terminals; and (ii) public passages within a building connecting with transport stations, interchanges and passenger terminals.

Item	2008 version	Amendments
<p>4. Section B in Division 10 of Chapter 4*</p>	<p>(d) Automatic door opener should be provided on the main entrance door of buildings not included in paragraph 45 and should:</p> <ul style="list-style-type: none"> (i) remain open for a minimum of 5 seconds; (ii) have a guardrail where it opens into a route of travel (see Figure 23); (iii) have a sign showing automatic door; and (iv) be located outside of the door swing. <p>Sliding automatic door with overhead sensor operating device or manual large button control should be provided.</p>	<p>(d) Other than a domestic building, automatic door openers should be provided on all entrance doors of a building which are commonly used by the public, and should:</p> <ul style="list-style-type: none"> (i) remain open for a minimum of 5 seconds; (ii) have a guardrail where it opens into a route of travel (see Figure 23); (iii) have a sign showing automatic door; and (iv) be located outside of the door swing. <p>Sliding automatic door with overhead sensor operating device or manual large button control should be provided.</p>
<p>5. Section B in Division 10 of Chapter 4*</p>		<p><i>To add a heading and paragraph (j) after paragraph (i) in Section B</i></p> <p>Unobstructed Area</p> <p>(j) An unobstructed area adjacent to the door handle on the leading face of a single door should not be less than 600 mm in width.</p>

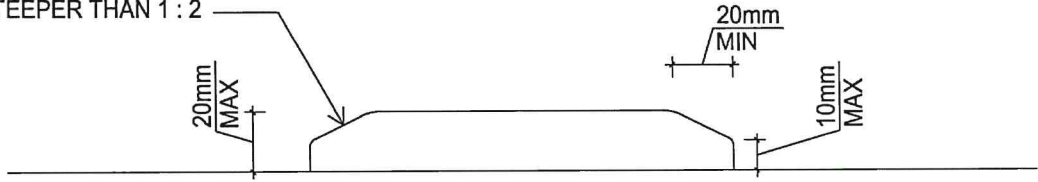
Item	2008 version	Amendments
6. Section B in Division 10 of Chapter 4*		<p data-bbox="913 181 1957 217"><i>To add a heading, paragraph (k) and Figure 23A after paragraph (j) in Section B</i></p> <p data-bbox="913 245 1137 280">Door Thresholds</p> <p data-bbox="913 306 2114 376">(k) Door threshold (see Figure 23A) should have a bevelled and round edge on each side at a gradient not steeper than 1:2.</p> <div data-bbox="913 443 2069 756" style="border: 2px solid yellow; padding: 10px;">  </div> <p data-bbox="913 810 1482 845">Figure 23A – Example of Door Threshold</p>

Item	2008 version	Amendments
<p>7. Figure 27 in Division 12 of Chapter 4*</p>	<p>(a) BATHROOM</p>	<p>(a) BATHROOM</p> <p>VERTICAL GRAB RAIL 100mm (MAX.) FROM BATHTUB RIM</p> <p>ADJUSTABLE SHOWER HEAD 450mm (MIN.) AND 850mm (MAX.) ABOVE FLOOR LEVEL</p>

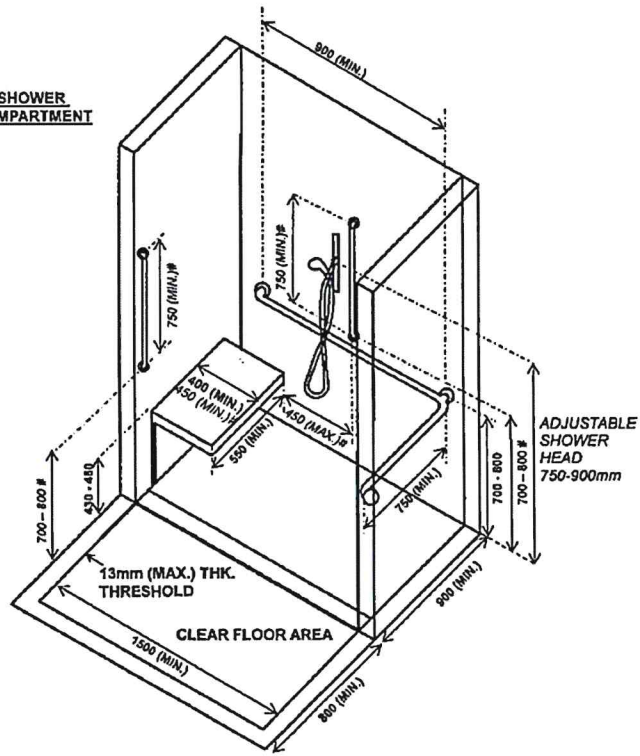
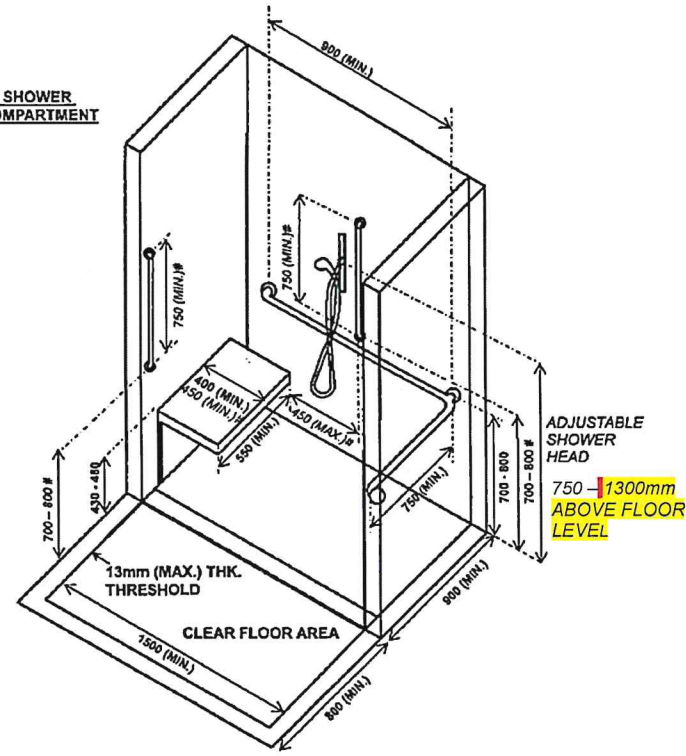
Item	2017 version	Amendments
	<p data-bbox="492 279 616 327">(b) SHOWER COMPARTMENT</p>  <p data-bbox="481 997 1075 1037"># VERTICAL GRAB RAILS AND SEAT DEPTH UNDER RECOMMENDED DESIGN REQUIREMENT</p> <p data-bbox="481 1053 1153 1141">* ALL DIMENSIONS ARE IN mm DIMENSIONS PRINTED IN BOLD FORM DENOTE OBLIGATORY DESIGN REQUIREMENTS DIMENSIONS PRINTED IN <i>ITALIC FORM</i> DENOTE RECOMMENDED DESIGN REQUIREMENTS</p> <p data-bbox="470 1165 1041 1189">Figure 27 - Examples of Bathroom and Shower Compartment</p>	<p data-bbox="1332 279 1456 327">(b) SHOWER COMPARTMENT</p>  <p data-bbox="1321 997 1915 1037"># VERTICAL GRAB RAILS AND SEAT DEPTH UNDER RECOMMENDED DESIGN REQUIREMENT</p> <p data-bbox="1321 1053 2004 1141">* ALL DIMENSIONS ARE IN mm DIMENSIONS PRINTED IN BOLD FORM DENOTE OBLIGATORY DESIGN REQUIREMENTS DIMENSIONS PRINTED IN <i>ITALIC FORM</i> DENOTE RECOMMENDED DESIGN REQUIREMENTS</p> <p data-bbox="1310 1165 1881 1189">Figure 27 - Examples of Bathroom and Shower Compartment</p>

Item	2019 version	Amendments
<p>8. Division 13 of Chapter 4##*</p>	<p>BEST PRACTICE SECTION</p> <p>A. Design Considerations</p> <p>Persons with visual impairment may have difficulty in identifying their lockers for public use.</p> <p>B. Recommended Design Requirements</p> <p>Each locker door in sports complex, public swimming pool complex or public areas should be provided with Braille cells and raised Arabic numerals/characters*.</p> <p>* The locker key holders should be provided with raised Arabic numerals/characters.</p>	<p>BEST PRACTICE SECTION</p> <p>A. Design Considerations</p> <p>Persons with visual impairment may have difficulty in identifying their locker for public use, and sanitary fitments in a public toilet or changing room.</p> <p>B. Recommended Design Requirements</p> <p>(a) Each locker door in a sports complex, public swimming pool complex or public area should be provided with the locker number in Braille and raised Arabic numerals/characters*.</p> <p>* The locker key holders should be provided with raised Arabic numerals/characters.</p> <p>(b) A Braille and tactile plan (see Figure 32A) should be provided for the toilets with five or more waterclosets (urinal in a public male toilet and changing room is regarded as a watercloset for this purpose) in a public toilet/changing room. The plan should be installed on the wall adjacent to the door of the public toilet/changing room, or their entrance if entrance door is not provided. The plan should be placed at 900 mm to 1500 mm above the finished floor level.</p>

Item	2019 version	Amendments
		 <p style="text-align: center;">420</p> <p style="text-align: center;">297</p> <p style="text-align: center;">男洗手間及更衣室觸覺點字及觸覺圖 Braille and Tactile Plan of Male Toilet & Changing Room</p> <p>圖例 Legend 你在此 You Are Here 出入口 Exit/Entrance 坐廁 Watercloset 洗手盆 Wash-basin 小便斗 Urinal 蹲廁 Squat Toilet 更衣間 Changing Area 沐浴間 Shower Area 儲物櫃 Locker 長椅 Bench</p> <p style="text-align: right;">(+0mm) Base Plate (+2mm) Tactile Feature (+4mm) (+4mm)</p>

Figure 32A – Example of Braille and Tactile Plan of Toilet and Changing Room

Item	2008 version	Amendments
9. Section A in Division 14 of Chapter 4#		<p><i>To add paragraph (fa) after paragraph (f) in Section A</i></p> <p>(fa) For any part of a building used for the purposes as office, hotel, guesthouse, hostel or bank, a tactile guide path should be installed from the main entrance of the building to lift zone, the nearest accessible toilet, public information/service counter, Braille and tactile floor plan, and staircase.</p>
10. Section B in Division 14 of Chapter 4*		<p><i>To add paragraph (ja) after paragraph (j) in Section B</i></p> <p>(ja) The Braille and tactile sign for public toilet required under paragraph 68(1) and (2) in Division 13 should be installed on the wall adjacent to the open side of the toilet door or toilet entrance if toilet door is not provided.</p>
11. Section A in Division 16 of Chapter 4#		<p><i>To add paragraph (c) after paragraph (b) in Section A</i></p> <p>(c) To enhance the illumination level of the lift lobby of upper floors, corridors, accessible paths and staircases, additional lighting to be provided may be activated by sensors. The following factors should be considered in setting the duration of such sensors:</p> <ul style="list-style-type: none"> (i) length of the corridors and paths; and (ii) walking speed of the persons with visual impairment, other forms of physical infirmities, etc.

Item	2008 version	Amendments
12. Section B in Division 16 of Chapter 4*		<p data-bbox="1122 229 1839 264"><i>To add paragraph (aa) after paragraph (a) in Section B</i></p> <p data-bbox="1122 293 2112 440">(aa) Lift lobby of upper floors, corridors, accessible paths and staircases should have an illumination level of not less than 120 lux measured at the finished floor level. Such enhanced illumination may be provided by additional lighting activated by sensors.</p>
13. Section B in Division 19 of Chapter 4*		<p data-bbox="1122 552 2007 587"><i>To add a heading and paragraph (i) after paragraph (h) in Section B</i></p> <p data-bbox="1122 616 1518 651">Mirror in Accessible Lift Car</p> <p data-bbox="1122 679 2112 890">(i) A non-breakable mirror or mirror-like surface should be provided inside an accessible lift car to allow visual feedback for wheelchair users when reversing backwards into the lift lobby. Such provision should have a clear width not less than 850 mm and its bottom and top edges should be not more than 300 mm and not less than 1800 mm above the floor of the lift car respectively.</p>

**Summary of Amendments to the Design Manual: Barrier Free Access 2008
(December 2021)**

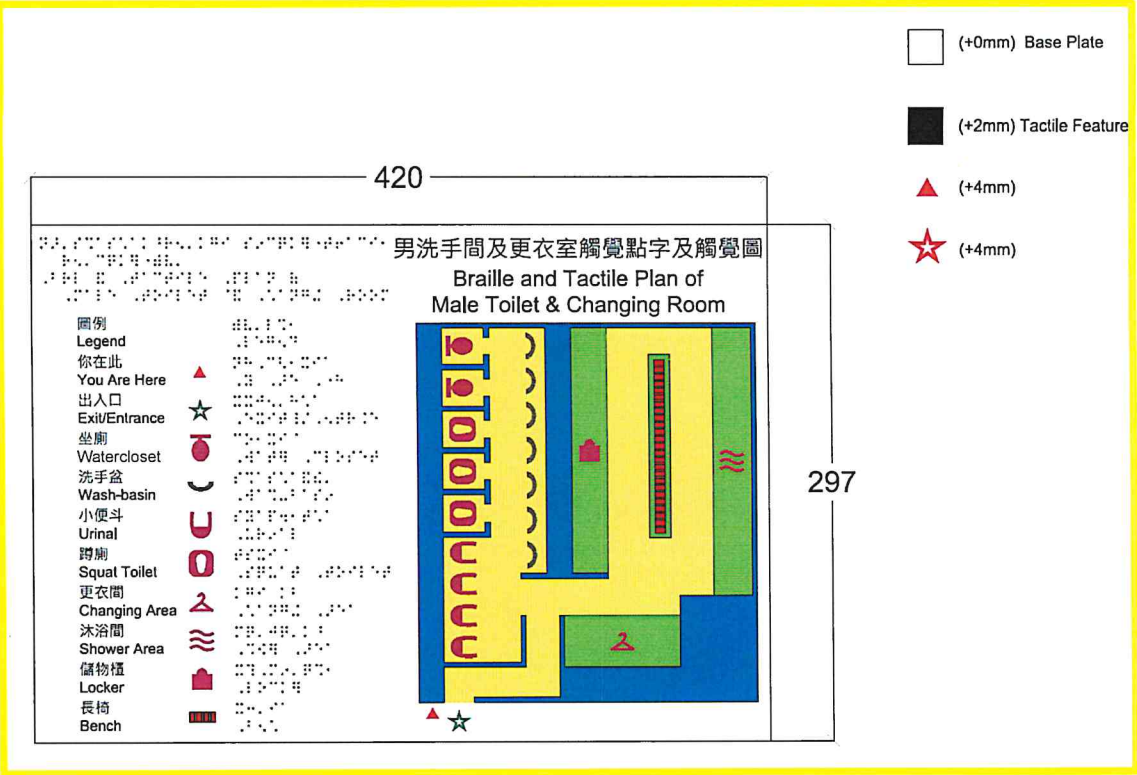
<i>Design Considerations and Recommended Design Requirements under Best Practice Section</i>	
1	Updated European Standard for keypad design of Destination Control System of lift control (item 1)
2	Considerations for setting duration of sensors of additional lighting (item 2)
3	Provision of resting places with resting facilities in long corridors and passageways (item 3)

Amendments to the Design Manual: Barrier Free Access 2008 (December 2021)

Legends:

 Amended

 Deleted

* Recommended Design Requirements under Best Practice Section

Design Guidelines for the Elderly and Elderly with Frailty

Item	2012 version	Amendments
<p>1. Paragraph (ba) in Section B following paragraph 83 in Division 19 of Chapter 4*</p>	<p>(viii) The design of the keypad shall comply with the international standards for the use of persons with a disability such as the European Standard EN 81-70:2003, Safety rules for the construction and installations of lifts - Particular applications for passenger and goods passenger lifts - Part 70: Accessibility to lifts for persons including persons with disability. Adequate signal and indication for use shall be provided including an illuminated visual indicator and an audible signal.</p>	<p>(viii) The design of the keypad should comply with the international standards for the use of persons with a disability such as the European Standard EN 81-70:2018, Safety rules for the construction and installations of lifts - Particular applications for passenger and goods passenger lifts - Part 70: Accessibility to lifts for persons including persons with disability. Adequate signal and indication for use should be provided including an illuminated visual indicator and an audible signal.</p>

Item	2008 version	Amendments
<p>2. Item 6.2.2 of the table in paragraph 6.2 of Chapter 6[#]</p>	<p>Recommended Design Guidelines</p> <p>Where changes in level are unavoidable, the floor and wall surfaces along the level difference shall be in luminous contrast.</p> <p>All common areas of a building should have an illumination level of not less than 120 lux measured at the finished floor level, and uniformity of illumination level should be maintained for any space.</p> <p>Alternative or stand-by light sources should be provided to illuminate any space in case of power failure.</p> <p>...</p>	<p>Recommended Design Guidelines</p> <p>Where changes in level are unavoidable, the floor and wall surfaces along the level difference should be in luminous contrast.</p> <p>All common areas of a building should have an illumination level of not less than 120 lux measured at the finished floor level, and uniformity of illumination level should be maintained for any space.</p> <p>Where additional lighting activated by sensors is provided to enhance the illumination level of the lift lobby of upper floors, corridors, accessible paths and staircases, the length of the corridors and paths and the walking speed of the elderly should be considered in setting the duration of such sensors.</p> <p>Alternative or stand-by light sources should be provided to illuminate any space in case of power failure.</p> <p>...</p>
<p>3. Item 6.2.3 of the table in paragraph 6.2 of Chapter 6[#]</p>	<p>Recommended Design Guidelines</p> <p>Resting places such as fold-down seats on stair landings or in long corridors should be provided. Resting places in external recreation spaces should be adequately provided.</p>	<p>Recommended Design Guidelines</p> <p>Resting places with resting facilities, such as seats (including fold-down seats) or lean-on railings, should be:</p> <p>(a) provided on stair landings;</p> <p>(b) provided in long corridors; and</p> <p>(c) adequately provided in external recreation spaces.</p> <p>Long corridors and passageways within transport stations, interchanges and passenger terminals, and public passages within a building connecting with transport stations, interchanges and passenger terminals should be provided with resting places with resting facilities. The resting facilities should be provided in recessed areas at maximum intervals of 50 m.</p>

Item	2008 version	Amendments
3. Item 6.2.3 of the table in paragraph 6.2 of Chapter 6# (cont'd)		Resting facilities should not reduce the statutory requirements on the clear width of access and manoeuvring space and should not cause obstruction to access, circulation and exit routes.