

MiC MODULE UNIT H & UNIT G (MIRRORED)  
 TYPE A1, A2, A3 & A4 & TYPE A1R, A2R, A3R & A4R (MIRRORED)

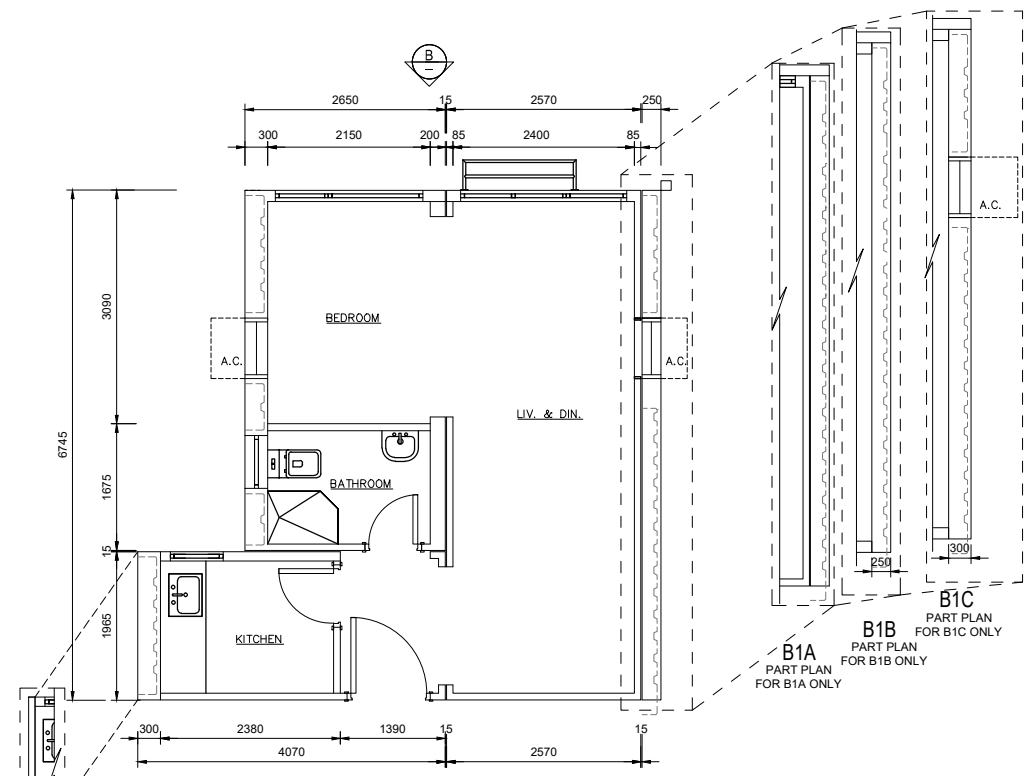

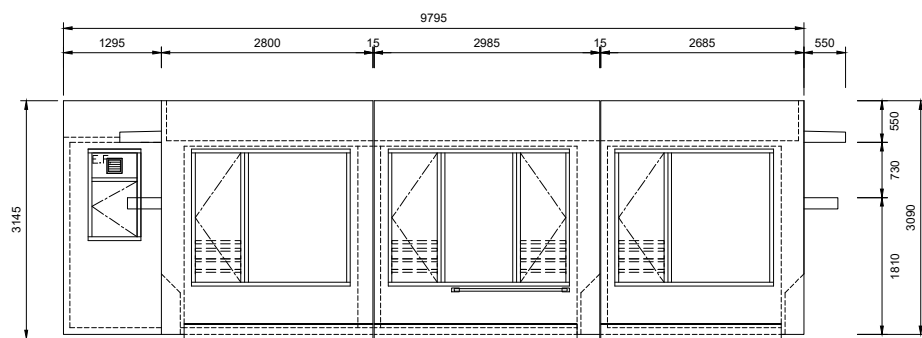

MiC MODULE UNIT J, S & UNIT K (MIRRORED)  
 TYPE B1, B2, B3 & TYPE B1R, B2R, B3R (MIRRORED)  
 MiC MODULE UNIT E & UNIT F, X (MIRRORED)  
 TYPE B1A, B2, B3 & TYPE B1AR, B2R, B3R (MIRRORED)  
 MiC MODULE UNIT L, Y & UNIT R (MIRRORED)  
 TYPE B1B, B2, B3A & TYPE B1BR, B2R, B3AR (MIRRORED)  
 MiC MODULE UNIT T  
 TYPE B1R, B2R, B3AR

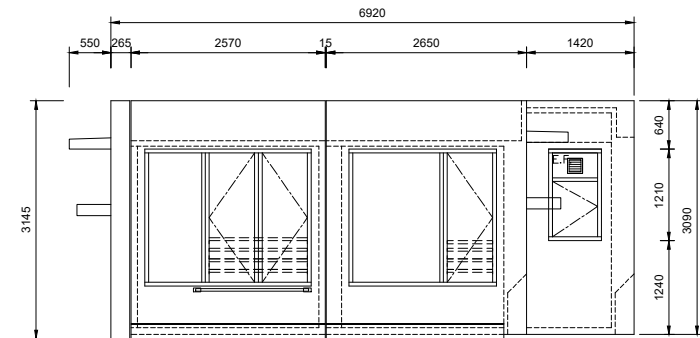

ELEVATION B



ELEVATION B

B.D. REF.		
F.S.D. REF.		
NOTES:		
1. DO NOT SCALE THIS DRAWING.		
2. FIGURED DIMENSIONS ARE TO BE FOLLOWED.		
3. READ THIS DRAWING IN CONJUNCTION WITH THE ARCHITECT'S SPECIFICATION & CONDITION OF CONTRACT.		
4. THIS DRAWING SHALL NOT BE USED FOR CONSTRUCTION PURPOSES UNLESS OTHERWISE CERTIFIED.		
5. THIS DRAWING AND DESIGN ARE COPYRIGHT AND NO PORTION MAY BE REPRODUCED WITHOUT THE WRITTEN PERMISSION OF THE ARCHITECTS.		
REV.	DATE	DESCRIPTION
MIC SUPPLIER		
 <b>YAU LEE WAH CONCRETE PRECAST PRODUCTS COMPANY LIMITED</b> 10/F, TOWER 1, ENTERPRISE SQUARE, 9 SHEUNG YUET ROAD, KOWLOON BAY, HONG KONG T +852 2753 4325 F +852 2753 4329 E ylwprecast@yaullee.com www.yaullee.com		
ARCHITECT		
 <b>OIYN LIMITED</b> FOR ARCHITECTS & ASSOCIATES 3/F, BLOCK A, CHEONG FAT FACTORY BUILDING, NO.265-271 LIN CHAU STREET, KLN TEL: 3469-1990 FAX: 3020-3409 EMAIL ADDRESS: mol@oiyn.com.hk		
STRUCTURAL ENGINEER		
		
AP		
<b>PUNG BRIAN PAK YAN</b> Authorized Person		
RSE		
PROJECT:		
<b>PROPOSED 32 STOREYS RESIDENTIAL DEVELOPMENT IN CONCRETE MIC (MODEL NO.: CONCRETE MIC 1.2 - 32)</b>		
DRAWING TITLE:		
<b>TYPICAL MODULE PLAN FOR MODULE UNITS TYPE A1-A4, A1R-A4R, B1-B3, B1R-B3R</b>		
DRAWN BY	SCALE	
KA PO		
CHECKED BY	DATE	
BP	17 OCT 2023	
JOB No.	DWG. NO.	REVISION
A-2304	WP-01	
B.D.'S OFFICIAL USE		

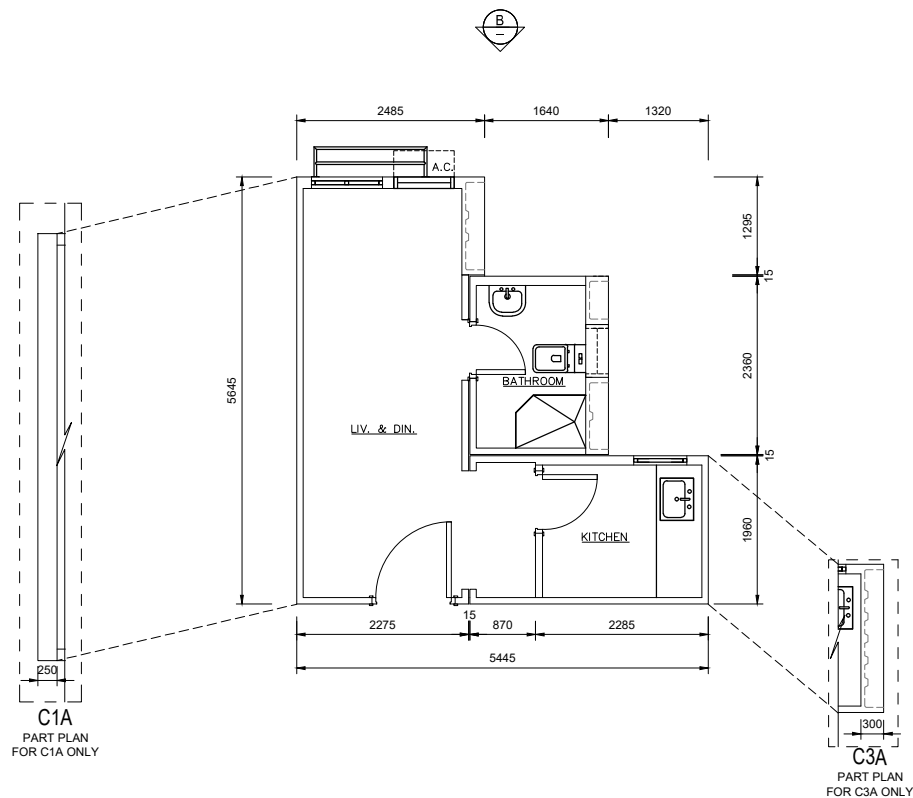

MiC MODULE UNIT Ab, M,P  
TYPE C1, C2, C3  
MiC MODULE UNIT Ad  
TYPE C1A, C2, C3  
MiC MODULE UNIT B, Z  
TYPE C1, C2, C3A

& UNIT Aa, C (MIRRORED)  
TYPE C1R, C2R, C3R (MIRRORED)  
& UNIT A, N (MIRRORED)  
TYPE C1AR, C2R, C3R (MIRRORED)  
& UNIT Ac, Q (MIRRORED)  
TYPE C1R, C2R, C3AR (MIRRORED)

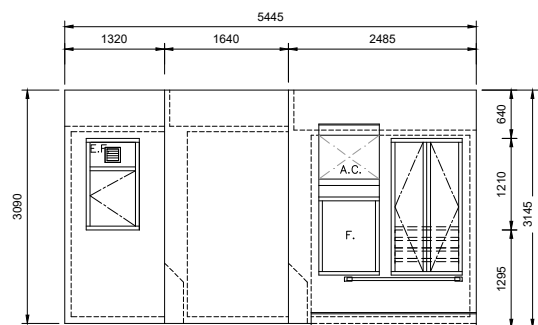

ELEVATION B

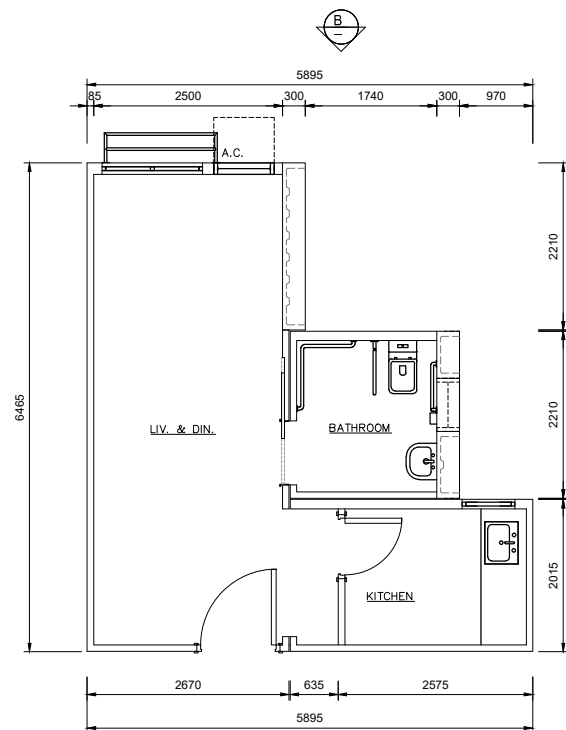

MiC MODULE UNIT D  
TYPE D1, D2, D3

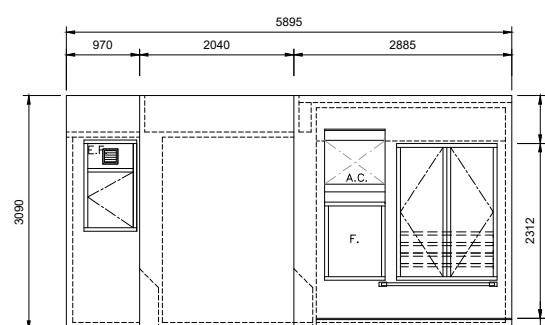

ELEVATION B

B.D. REF.		
F.S.D. REF.		
NOTES: 1. DO NOT SCALE THIS DRAWING. 2. FIGURED DIMENSIONS ARE TO BE FOLLOWED. 3. READ THIS DRAWING IN CONJUNCTION WITH THE ARCHITECT'S SPECIFICATION & CONDITION OF CONTRACT. 4. THIS DRAWING SHALL NOT BE USED FOR CONSTRUCTION PURPOSES UNLESS OTHERWISE CERTIFIED. 5. THIS DRAWING AND DESIGN ARE COPYRIGHT AND NO PORTION MAY BE REPRODUCED WITHOUT THE WRITTEN PERMISSION OF THE ARCHITECTS.		
REV.	DATE	DESCRIPTION
MIC SUPPLIER YAU LEE WAH CONCRETE PRECAST PRODUCTS COMPANY LIMITED 10/F, TOWER 1, ENTERPRISE SQUARE, 9 SHEUNG YUET ROAD, KOWLOON BAY, HONG KONG T +852 2753 4325 F +852 2753 4329 E ylp@pcast@yaullee.com www.yaullee.com		
ARCHITECT <b>OIYN LIMITED</b> FOR ARCHITECTS & ASSOCIATES 3/F, BLOCK A, CHEUNG FAT FACTORY BUILDING, NO.265-271 UN CHAU STREET, KLN TEL: 3469-1990 FAX: 3020-9409 EMAIL ADDRESS: mol@oiyn.com.hk		
STRUCTURAL ENGINEER <b>JACOBS</b>		
AP  <b>PUNG BRIAN PAK YAN</b> Authorized Person		
RSE		
PROJECT: PROPOSED 32 STOREYS RESIDENTIAL DEVELOPMENT IN CONCRETE MIC (MODEL NO.: CONCRETE MIC 1.2 - 32)		
DRAWING TITLE: TYPICAL MODULE PLAN FOR MODULE UNITS TYPE C1-C3, C1R-C3R, C1A-C3A AND D1-D3		
DRAWN BY KA PO	SCALE	
CHECKED BY BP	DATE 17 OCT 2023	
JOB No. A-2304	DWG NO. WP-02	REVISION
BD'S OFFICIAL USE		

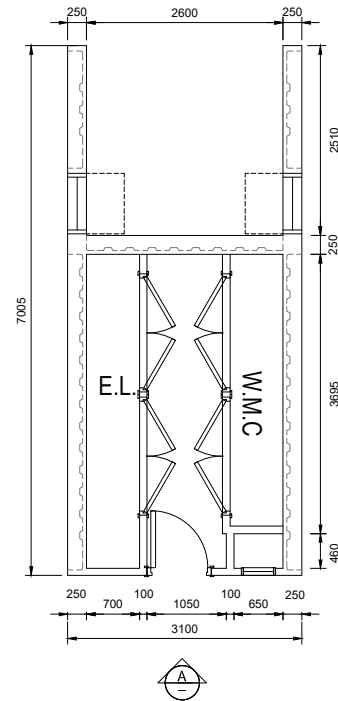

**MiC MODULE EMR  
TYPE E**

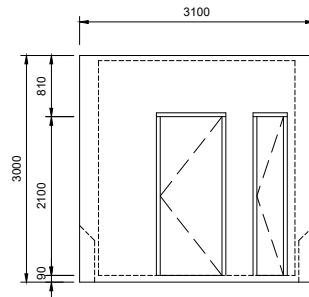

**ELEVATION A**

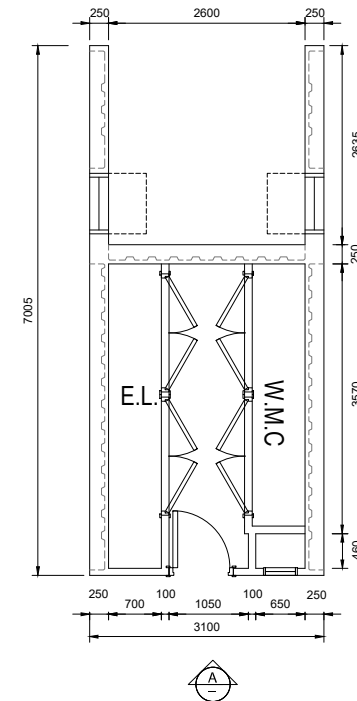

**MiC MODULE EMR  
TYPE E1**

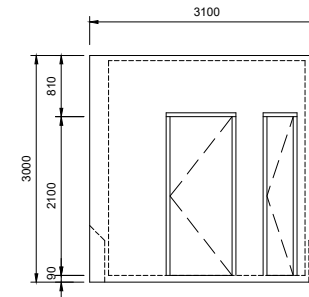

**ELEVATION A**

B.D. REF.

F.S.D. REF.

- NOTES:
- DO NOT SCALE THIS DRAWING;
  - FIGURED DIMENSIONS ARE TO BE FOLLOWED;
  - READ THIS DRAWING IN CONJUNCTION WITH THE ARCHITECT'S SPECIFICATION & CONDITION OF CONTRACT;
  - THIS DRAWING SHALL NOT BE USED FOR CONSTRUCTION PURPOSES UNLESS OTHERWISE CERTIFIED;
  - THIS DRAWING AND DESIGN ARE COPYRIGHT AND NO PORTION MAY BE REPRODUCED WITHOUT THE WRITTEN PERMISSION OF THE ARCHITECTS.

REV.	DATE	DESCRIPTION

MIC SUPPLIER

**YAU LEE WAH CONCRETE PRECAST PRODUCTS COMPANY LIMITED**

10/F, TOWER 1, ENTERPRISE SQUARE,  
9 SHEUNG YUET ROAD, KOWLOON BAY, HONG KONG  
T +852 2753 4325  
F +852 2753 4329  
E ylwpcast@yaullee.com  
www.yaullee.com

ARCHITECT

**OIYN LIMITED**  
FOR ARCHITECTS & ASSOCIATES

1/F, BLOCK A, CHEONG FAT FACTORY BUILDING, NO.265-271 LIN CHAU STREET, KLN  
TEL: 3489-1990 FAX: 3020-9409 EMAIL ADDRESS: mail@oiyn.com.hk

STRUCTURAL ENGINEER

**JACOBS**

AP

**FUNG BRIAN PAK YAN**  
Authorized Person

RSE

PROJECT:

**PROPOSED 32 STOREYS RESIDENTIAL DEVELOPMENT IN CONCRETE MIC (MODEL NO.: CONCRETE MIC 1.2 - 32)**

DRAWING TITLE:

**TYPICAL MODULE PLAN FOR MODULE UNITS TYPE E AND E1**

DRAWN BY KA PO	SCALE
CHECKED BY BF	DATE 17 OCT 2023

JOB No. A-2304	DWG. NO. WP-03	REVISION
-------------------	-------------------	----------

BD'S OFFICAL USE